

PRICE LIST No. 1

LEAD BLOWN TUMBLERS
AND STEMWARE



The
Cambridge Glass Co.

CAMBRIDGE, OHIO



THE AMERICAN BACCARAT

*Items checked ✓ thus are now ready for shipment **

PRICE LIST No. 1

**LEAD BLOWN TUMBLERS
AND STEMWARE**



**The
Cambridge Glass Co.**

CAMBRIDGE, OHIO



THE AMERICAN BACCARAT

NOTICE.

In this Price List will be found quotations on complete lines in various designs in cuttings, etchings, etc. Our Illustrated Catalogue, which accompanies the list, shows sizes and patterns in plain goods, and sufficient illustrations are shown of cut, etched, decorated and engraved, to enable the buyer, by referring to this list, to make selections.

Cut and Etched Goods are made to order, and may be packed as desired.

Numbers of dozens packed in barrel may vary from printed list, as also gross weight of barrels given in list, owing to different methods of packing. The information given in these two columns is therefore approximate, but will aid buyers in computing cost.

Capacities.—Capacity given is fluid measurement of 16 ounces to the pint, and is as nearly accurate as possible, but we do not guarantee capacities.

Breakage.—As we have all our glass put up by experienced packers in the most neat and careful manner, we make no allowance for breakage, our Bills of Lading being guarantee of good order when shipped; also, that number of packages called for were shipped, and in case of shortage same should be deducted from freight before payment is made to transportation company.

Terms.—All accounts are due and payable within 60 days from date of invoice. A discount of 2 per cent. will be allowed if paid within 30 days from date of invoice.

Deliveries.—All goods are sold Free on Board Cars at our plant.

Prices subject to change without notice.

All sales and contracts made by this company subject to strikes, accidents, fires or other unavoidable delays.

LEAD GLASS BLOWN TUMBLERS.

Unselected Quality, Unless Otherwise Ordered.

First Quality 33 1-3 per cent. Advance Over Unselected.

No.	Oz.			Price Dozen Plain	Price Dozen Optic	Price Dozen Punty	Doz. in Bbl.
8101	✓ 1½	Light Taper Bar	\$ 26	\$ 36	\$ 36	150
	✓ 1¾	"	26	36	36	140
	✓ 1¾	"	26	36	36	140
	✓ 2	"	26	36	36	125
	✓ 2¼	✓	26	36	36	115
	✓ 2½	✓	26	36	36	110
	✓ 2¾	✓	26	36	36	100
	✓ 3	✓	26	36	36	100
	✓ 3¼	"	26	36	36	90
	✓ 3½	"	28	38	38	90
	✓ 3¾	"	28	38	38	85
	✓ 4	"	28	38	38	80
	✓ 4½	✓	33	43	43	80
	5	✓	33	43	43	75
	5½	"	35	45	45	70
	6	"	35	45	45	70
	6½	"	37	47	47	65
8102	1	Light Taper Bar	26	36	36	150
	✓ 1½	"	26	36	36	150
	✓ 1¾	"	26	36	36	140
	✓ 2	✓	26	36	36	125
	✓ 2¼	✓	26	36	36	120
	✓ 2½	✓	26	36	36	110
	✓ 2¾	✓	26	36	36	100
	✓ 3	✓	26	36	36	100
	✓ 3½	"	28	38	38	90
	✓ 4	✓	28	38	38	85
	✓ 4¼	✓	33	43	43	80
	✓ 4½	✓	33	43	43	75
	5	"	33	43	43	70
	6	"	35	45	45	65
8103	✓ 1½	Light Taper Bar	26	36	36	150
	✓ 2	✓	26	36	36	125
	✓ 2¼	✓	26	36	36	120
	✓ 2½	✓	26	36	36	110
	✓ 2¾	✓	26	36	36	100
	✓ 3	✓	26	36	36	95
	✓ 3½	"	28	38	38	95
	✓ 3¾	"	28	38	38	90
	✓ 4	"	28	38	38	80
	✓ 4½	"	33	43	43	75
	4¾	"	33	43	43	75
	5	"	33	43	43	75

Old Rochester Tumbler Company's numbers, shapes and sizes. Complete lines shown above can be had either in plain or optic. Cuts on opposite page actual size.

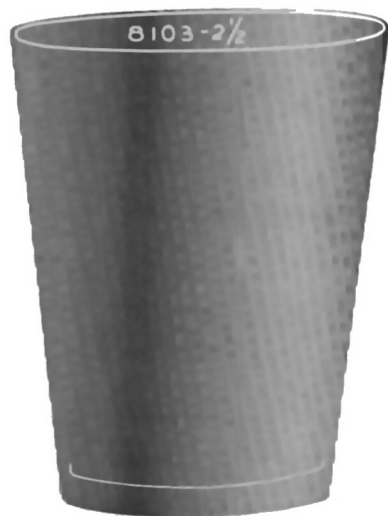
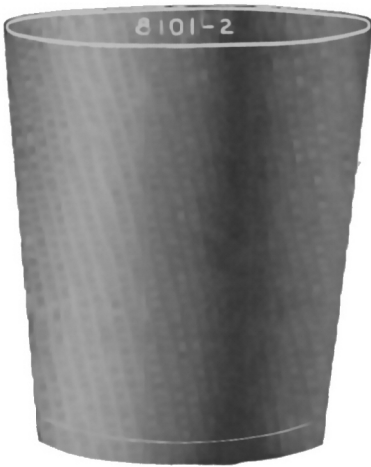

LEAD GLASS BLOWN TUMBLERS.

Unselected Quality, Unless Otherwise Ordered.

First Quality 33 1-3 per cent. Advance Over Unselected.

No.	Oz.		Price Dozen Plain	Price Dozen Optic	Price Dozen Punty	Doz. in Bbl.
8104	1 $\frac{1}{8}$	Light Taper Bar.....	\$ 26	\$ 36	\$ 36	150
	✓ 1 $\frac{1}{3}$	"	26	36	36	150
	✓ 1 $\frac{1}{2}$	"	26	36	36	125
	1 $\frac{3}{4}$	"	26	36	36	125
	✓ 2 ✓	"	26	36	36	125
	✓ 2 $\frac{1}{4}$	"	26	36	36	125
	✓ 2 $\frac{1}{2}$ ✓	"	26	36	36	115
	2 $\frac{3}{4}$	"	26	36	36	100
	3	"	26	36	36	100
8105	4 $\frac{1}{4}$	Light Taper Bar.....	33	43	43	75
	4 $\frac{1}{2}$	"	33	43	43	75
	5	"	33	43	43	65
8107	✓ 2	Light Taper Bar.....	26	36	36	125
	✓ 2 $\frac{1}{4}$	"	26	36	36	120
	✓ 2 $\frac{1}{2}$ ✓	"	26	36	36	120
	✓ 2 $\frac{3}{4}$	"	26	36	36	100
	✓ 3 ✓	"	26	36	36	95
	3 $\frac{1}{4}$	"	26	36	36	95
	3 $\frac{1}{2}$	"	28	38	38	95
	3 $\frac{3}{4}$	"	28	38	38	90
	4	"	28	38	38	80
	4 $\frac{1}{4}$	"	33	43	43	75
	4 $\frac{1}{2}$	"	33	43	43	75
	5	"	33	43	43	65
8108	4 $\frac{1}{2}$	Light Taper Bar.....	33	43	43	75
8111	1	Light Straight Bar.....	26	36	36	150
	1 $\frac{1}{2}$	"	26	36	36	125
	2	"	26	36	36	100
	2 $\frac{1}{2}$	"	26	36	36	90
	3	"	26	36	36	80
	3 $\frac{1}{2}$	"	28	38	38	65
	3 $\frac{3}{4}$	"	28	38	38	60
	4	"	28	38	38	60
	4 $\frac{1}{2}$	"	33	43	43	50
8112	2	Light Tub Bar.....	26	36	36	100
	2 $\frac{1}{2}$	"	26	36	36	70
	3	"	26	36	36	65
	3 $\frac{1}{2}$	"	28	38	38	50
	3 $\frac{3}{4}$	"	28	38	38	50
	4	"	28	38	38	45
	4 $\frac{1}{2}$	"	33	43	43	40
	5	"	33	43	43	40

*Cut 6
Z.P.*

Old Rochester Tumbler Company's numbers, shapes and sizes. Complete lines shown above can be had either in plain or optic. Cuts on opposite page actual size.

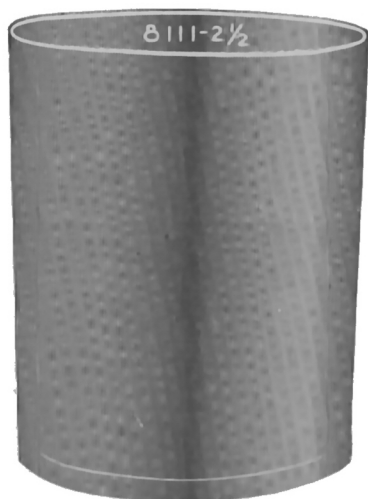
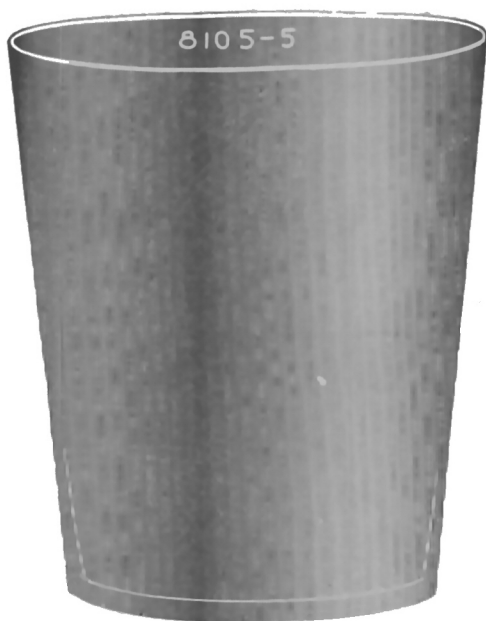

LEAD GLASS BLOWN TUMBLERS.

Unselected Quality, Unless Otherwise Ordered.

First Quality 33 1-3 per cent. Advance Over Unselected.

No.	Oz.		Price Dozen Plain	Price Dozen Optic	Price Dozen Punty	Doz. in Bbl.
8116	3	Light Concave Bar.....	\$ 32	\$ 42	\$ 42	50
	4	"	35	45	45	42
	4½	"	37	47	47	40
	4	Light Concave Bar Handled.....	85	95	95	36
	4½	" " " "	87	97	97	34
8121	¾	Medium Straight Bar.....	34	44	44	150
	1¼	"	34	44	44	125
	1¾	"	34	44	44	100
	2	"	34	44	44	90
	2½	"	34	44	44	80
	3	"	34	44	44	65
	3¼	"	34	44	44	60
	3½	"	36	46	46	50
	8122	1½	Medium Tub Bar.....	34	44	44
2		"	34	44	44	80
2½		"	34	44	44	75
3		"	34	44	44	70
3½		"	36	46	46	70
3¾		"	36	46	46	50
4		"	36	46	46	48
4½		"	42	52	52	48
8125	1	Sham Taper Bar.....	41	51	51	115
	✓ 1½ ✓	"	41	51	51	100
	1¾	"	41	51	51	90
	✓ 2 ✓	"	41	51	51	80
	✓ 2¼ ✓	"	41	51	51	70
	✓ 2½ ✓	"	41	51	51	65
	✓ 3 ✓	"	41	51	51	55
	3¼	"	41	51	51	50
	✓ 3½ ✓	"	43	53	53	50
	4	"	43	53	53	40
	4½	"	48	58	58	36
	5	"	48	58	58	33
	5½	"	50	60	60	28
8126	✓ 2 ✓	Sham Taper Bar.....	41	51	51	75
	✓ 2½ ✓	"	41	51	51	70
	✓ 3 ✓	"	41	51	51	55
	✓ 3½ ✓	"	43	53	53	50
	✓ 4 ✓	"	43	53	53	45
	✓ 4½ ✓	"	48	58	58	40

Old Rochester Tumbler Company's numbers, shapes and sizes. Complete lines shown above can be had either in plain or optic. Cuts on opposite page actual size.

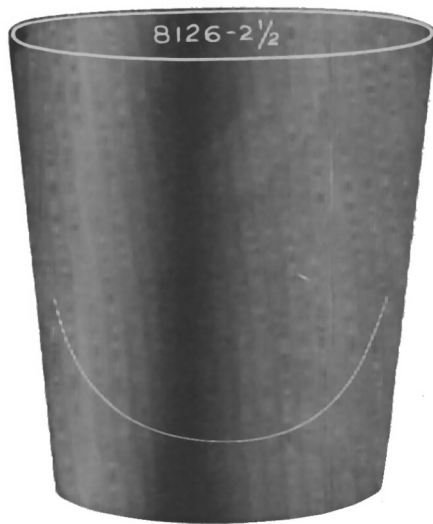
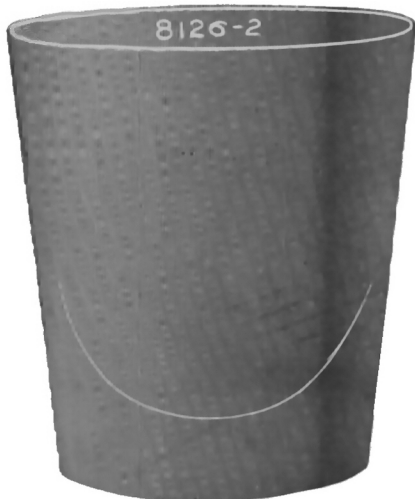
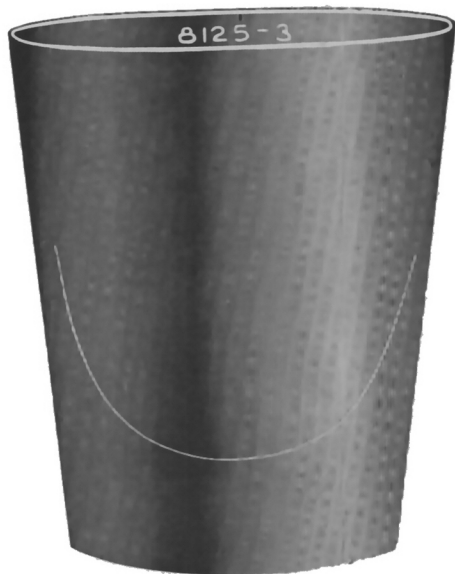
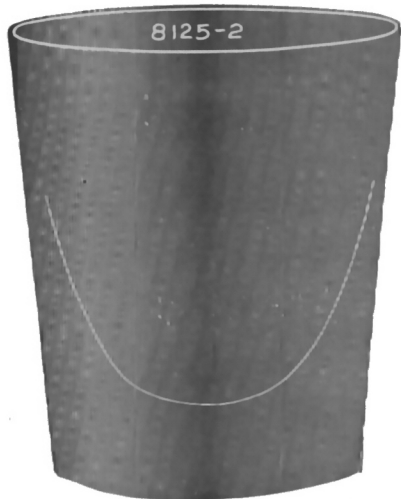
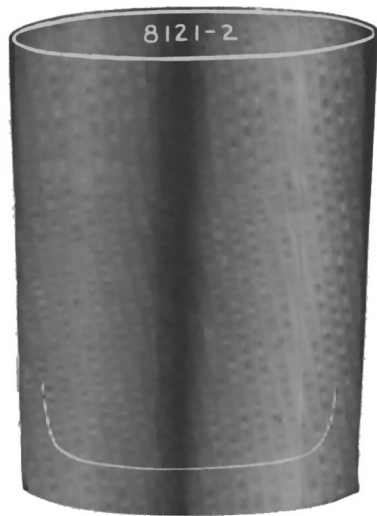

LEAD GLASS BLOWN TUMBLERS.

Unselected Quality, Unless Otherwise Ordered.
First Quality 33 1-3 per cent. Advance Over Unselected.

No.	Oz.		Price Dozen Plain	Price Dozen Optic	Price Dozen Punty	Doz. in Bbl.
8127	✓ 1	Sham Taper Bar.....	\$ 41	\$ 51	\$ 51	150
	✓ 1½	"	41	51	51	130
	✓ 1¾	"	41	51	51	125
	✓ 2	"	41	51	51	120
	✓ 2¼	"	41	51	51	120
	✓ 2½	"	41	51	51	115
	✓ 2¾	"	41	51	51	100
	✓ 3	"	41	51	51	90
	✓ 3½	"	43	53	53	70
	✓ 4	"	43	53	53	60
	✓ 4½	"	48	58	58	50
	5	"	48	58	58	50
8128	1½	Sham Taper Bar.....	41	51	51	130
	✓ 1¾	"	41	51	51	120
	✓ 2	"	41	51	51	115
	✓ 2¼	"	41	51	51	115
	✓ 2½	"	41	51	51	110
	✓ 2¾	"	41	51	51	110
	✓ 3	"	41	51	51	100
	✓ 3¼	"	41	51	51	90
	✓ 3½	"	43	53	53	85
	✓ 3¾	"	43	53	53	80
	✓ 4	"	43	53	53	70
	4½	"	48	58	58	70
8129	1¾	Medium Taper Bar.....	34	44	44	80
	✓ 2	"	34	44	44	75
	✓ 2¼	"	34	44	44	70
	✓ 2½	"	34	44	44	65
	✓ 2¾	"	34	44	44	63
	✓ 3	"	34	44	44	63
	✓ 3¼	"	34	44	44	60
	✓ 3½	"	36	46	46	55
	✓ 3¾	"	36	46	46	50
	✓ 4	"	36	46	46	45
	4½	"	42	52	52	45
	5	"	42	52	52	45
	5½	"	44	54	54	45
8141	✓ 1¼	Sham Taper Bar.....	41	51	51	80
	✓ 2	"	41	51	51	70
	✓ 2½	"	41	51	51	60
8142	✓ 1½	Sham Taper Base.....	41	51	51	80
	✓ 1¾	"	41	51	51	75
	✓ 2	"	41	51	51	70
	✓ 2½	"	41	51	51	60

Old Rochester Tumbler Company's numbers, shapes and sizes. Complete lines shown above can be had either in plain or optic. Cuts on opposite page actual size.

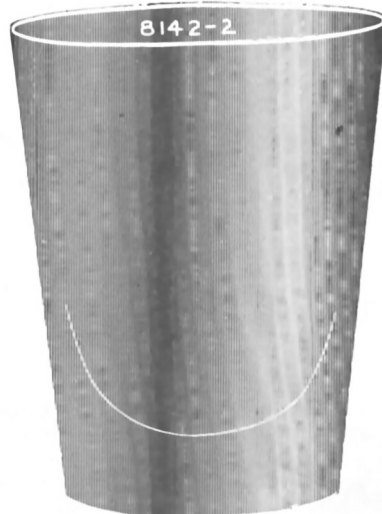
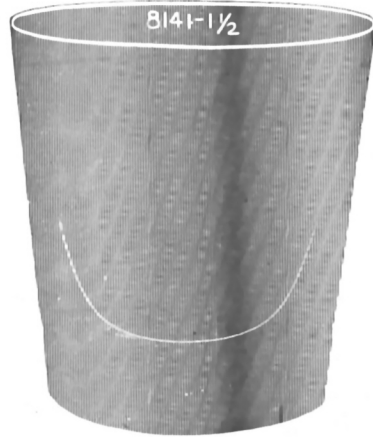
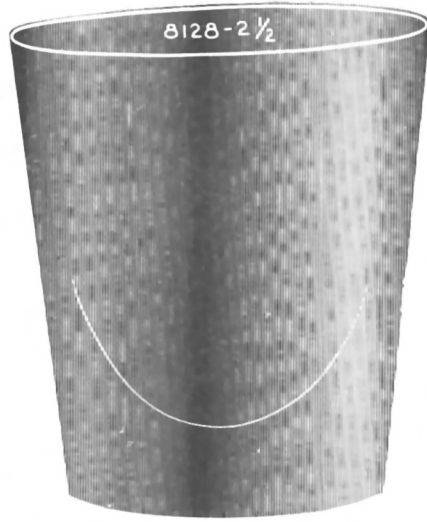
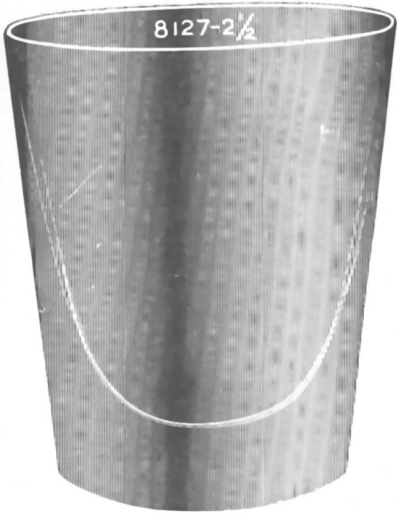

LEAD GLASS BLOWN TUMBLERS.

Unselected Quality, Unless Otherwise Ordered.

First Quality 33 1-3 per cent. Advance Over Unselected.

No.	Oz.		Price Dozen Plain	Price Dozen Optic	Price Dozen Punty	Doz in Bbl.
8143	✓ 7	Sham Taper Bar	\$ 57	\$ 67	\$ 67	25
	9	"	62	72	72	20
8151	✓ 1½	Sham Concave Bar	47	57	57	75
	✓ 1½	"	47	57	57	70
	✓ 1¾	"	47	57	57	70
	✓ 2	"	47	57	57	60
	✓ 2½	"	47	57	57	60
8161	2	Light Barrel	32	42	42	100
	2½	"	32	42	42	80
	3	"	32	42	42	60
	4	"	35	45	45	45
	5	"	37	47	47	35
	6	"	39	49	49	32
	7	"	40	50	50	30
	✓ 7	"	Handled	1 00	1 00	25
	8	"	41	51	51	24
	9	"	44	54	54	22
	10	"	45	55	55	20
	11	"	60	75	75	18
	12	"	66	83	83	15
	14	"	80	95	95	14
	16	"	1 00	1 15	1 15	12
8162	6	Light Barrel	39	49	49	35
	8	"	41	51	51	24
	10	"	45	55	55	20
8171	2½	Medium Barrel	40	50	50	80
	2¾	"	40	50	50	60
	3¾	"	43	53	53	45
	4½	"	46	56	56	35
	5½	"	48	58	58	32
	✓ 6½	"	52	62	62	30
	7½	"	53	63	63	30
	8½	"	56	66	66	22
	9½	"	62	72	72	20
	10½	"	77	92	92	18
8201	2	Light Taper Bar	26	36	36	125
	2¼	"	26	36	36	125
	3	"	26	36	36	95
	3½	"	28	38	38	95
8202	2	Light Taper Bar	26	36	36	125
	2½	"	26	36	36	110
	3	"	26	36	36	95

Old Rochester Tumbler Company's numbers, shapes and sizes. Complete lines shown above can be had either in plain or optic. Cuts on opposite page actual size.

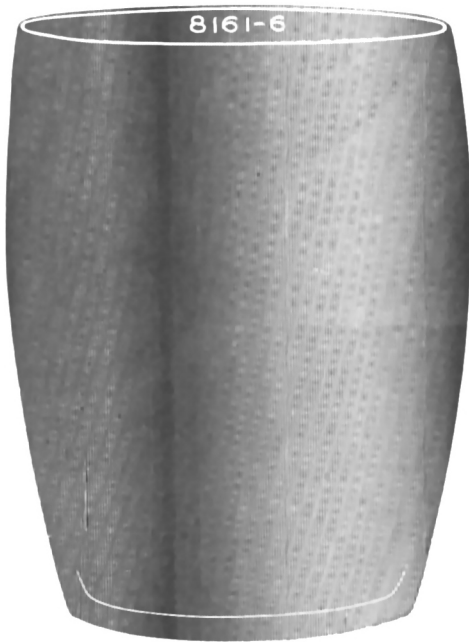
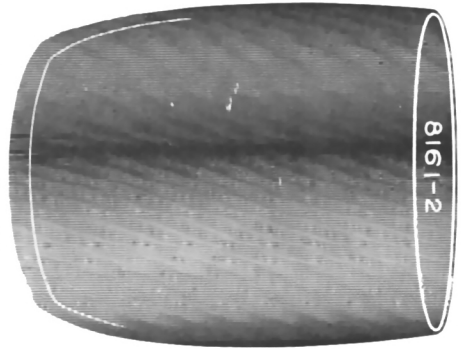
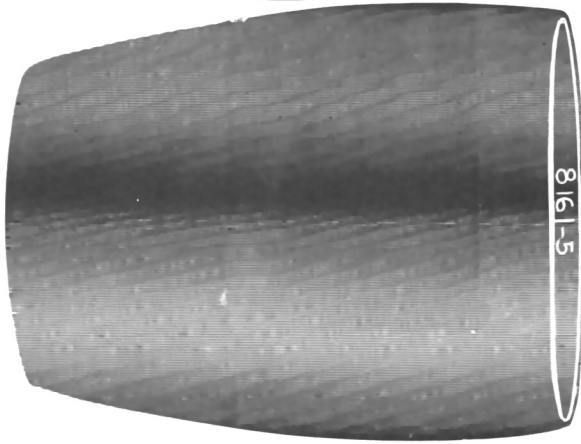
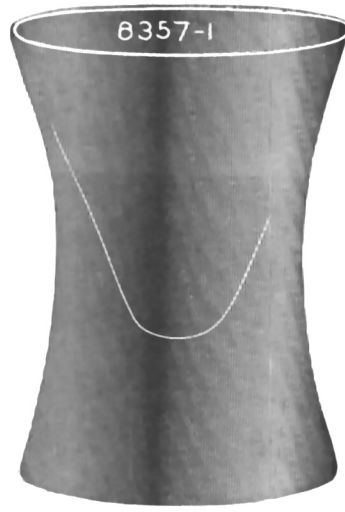

LEAD GLASS BLOWN TUMBLERS.

Unselected Quality, Unless Otherwise Ordered.

First Quality 33 1-3 per cent. Advance Over Unselected.

No.	Oz.		Price Dozen Plain	Price Dozen Optic	Price Dozen Punty	Doz. in Bbl.
8357	✓ 1	Sham Concave Bar	\$ 47	\$ 57	\$ 57	100
8358	✓ 4	Sham Taper Bar	53	63	63	35
	5	"	55	65	65	32
	✓ 6	"	64	74	74	28
8400	4¾	Light Taper	35	45	45	65
	19	"	1 15	1 30	1 30	20
8401	✓ 3	Light Taper	30	40	40	85
	✓ 3½	"	33	43	43	80
	✓ 4	"	33	43	43	75
	✓ 4½	"	35	45	45	65
	✓ 5	"	35	45	45	60
	5½	"	36	46	46	55
	✓ 6	"	36	46	46	50
	✓ 7	"	37	47	47	45
	✓ 8	"	38	48	48	40
	✓ 9	"	42	52	52	35
	✓ 10	"	42	52	52	35
	✓ 11	"	48	63	63	32
	✓ 12	"	55	70	70	28
	✓ 13	"	60	75	75	28
	✓ 14	"	70	85	85	25
	15	"	75	90	90	22
	✓ 16	"	82	97	97	22
	✓ 18	"	95	1 10	1 10	20
	✓ 21	"	1 30	1 45	1 45	15
8402	✓ 4	Light Taper	33	43	43	75
	✓ 5	"	35	45	45	60
	✓ 6	"	36	46	46	50
	✓ 7	"	37	47	47	45
	✓ 8	"	38	48	48	40
	8½	"	42	52	52	40
	✓ 9	"	42	52	52	35
	✓ 10	"	42	52	52	35
	11	"	48	63	63	32
	✓ 12	"	55	70	70	28
	✓ 12½	Light Taper	58	73	73	28
	13	"	60	75	75	28
	✓ 14	"	70	85	85	25
	15	"	75	90	90	22
	✓ 16	"	82	97	97	22
	18	"	95	1 10	1 10	20
	19	"	1 15	1 30	1 30	20
	20	"	1 15	1 30	1 30	18
	21	"	1 30	1 60	1 60	15

Old Rochester Tumbler Company's numbers, shapes and sizes. Complete lines shown above can be had either in plain or optic. Cuts on opposite page actual size.

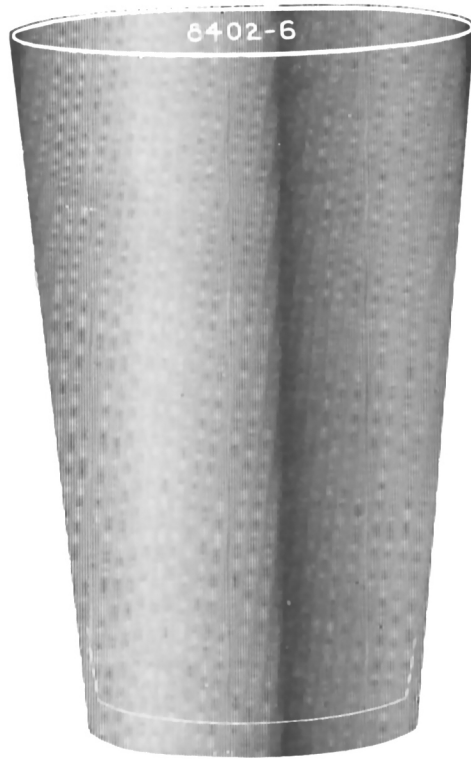
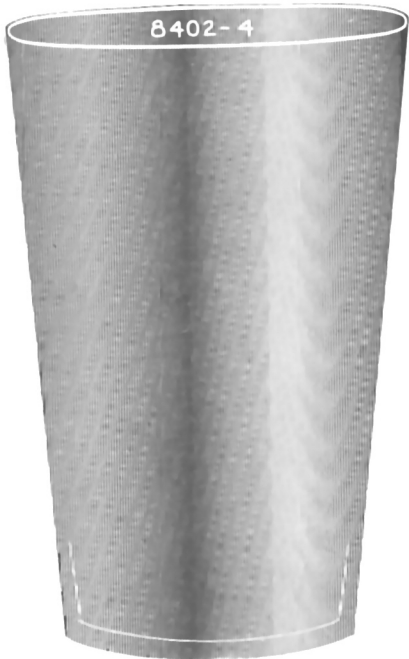
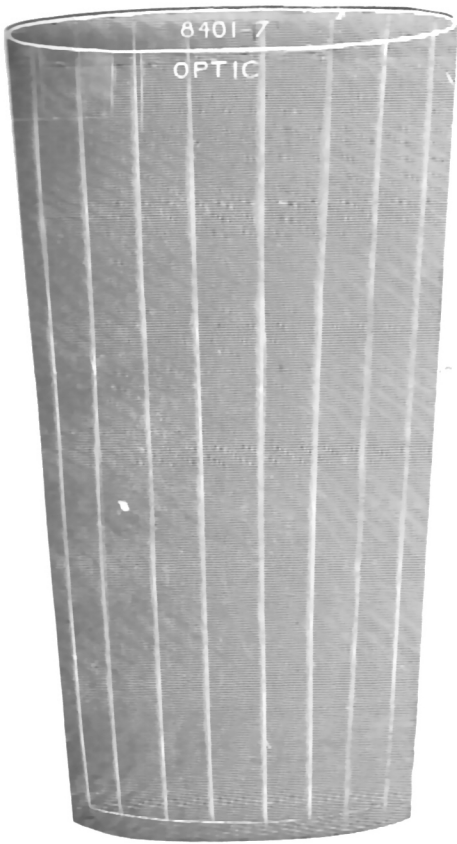

LEAD GLASS BLOWN TUMBLERS.

Unselected Quality, Unless Otherwise Ordered.

First Quality 33 1-3 per cent. Advance Over Unselected.

No.	Oz.		Price Dozen Plain	Price Dozen Optic	Price Dozen Punty	Doz. in Bbl
8403	4	Light Taper	\$ 33	\$ 43	\$ 43	80
	4½	"	35	45	45	75
	5	"	35	45	45	60
	5½	"	36	46	46	55
	7½	"	38	48	48	42
	8	"	38	48	48	40
	10½	"	48	63	63	32
	11	"	48	63	63	30
	13	"	60	75	75	28
	13	Double Thick Taper	78	93	93	25
	14	Light Taper	70	85	85	25
8405	4	Tall Taper Lemonade	33	43	43	75
	9	"	50	60	60	18
	9	" Handled	1 00	1 10	1 10	16
8408	4½	Light Taper Seltzer	35	45	45	65
8411	9	Tall Taper Soda	42	52	52	35
	10	"	42	52	52	32
	✓ 12	"	55	70	70	25
	13	"	60	75	75	22
	14	"	70	85	85	20
8412	9	Squat Taper Soda	42	52	52	35
	✓ 12	"	55	70	70	25
	✓ 13	"	60	75	75	20
	✓ 14	✓ "	70	85	85	20
8413	12	Flare Top Lemonade	60	75	75	20
8421	✓ 4	Sham Taper	48	58	58	40
	✓ 4½	"	50	60	60	35
8425	12	Medium Table	72	87	87	25
8502	9	Taper Beer	42	52	52	35
	14	" Lemonade	70	85	85	25
	18	" Beer	95	1 10	1 10	22

Old Rochester Tumbler Company's numbers, shapes and sizes. Complete lines shown above can be had either in plain or optic. Cuts on opposite page actual size.

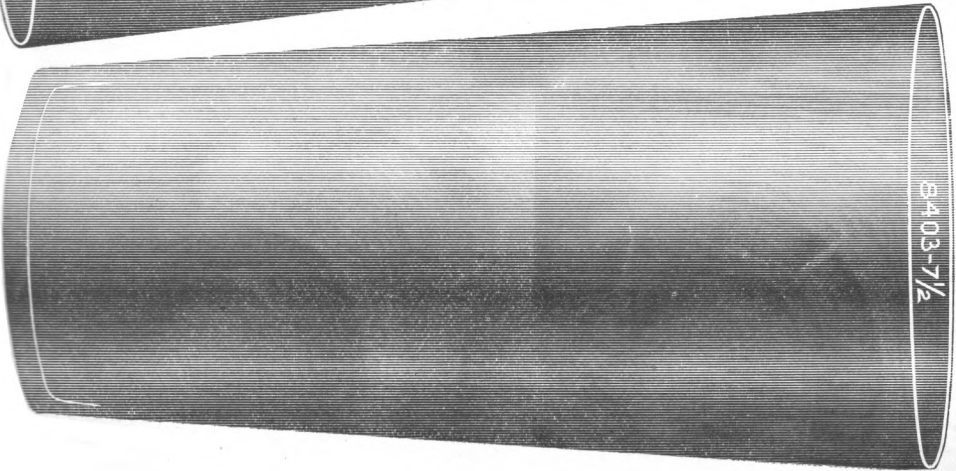
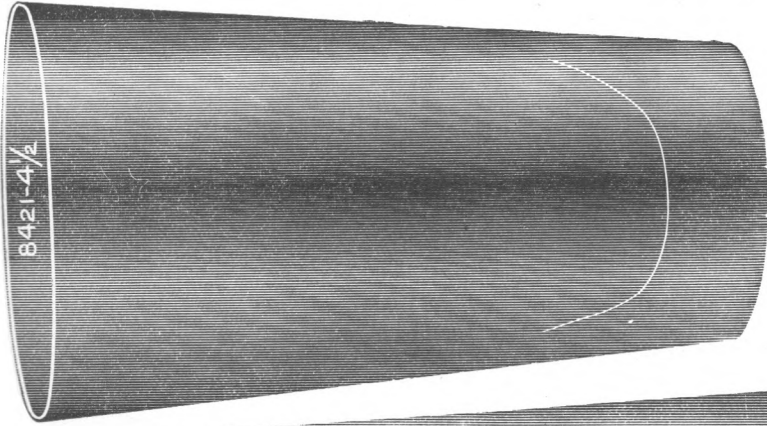
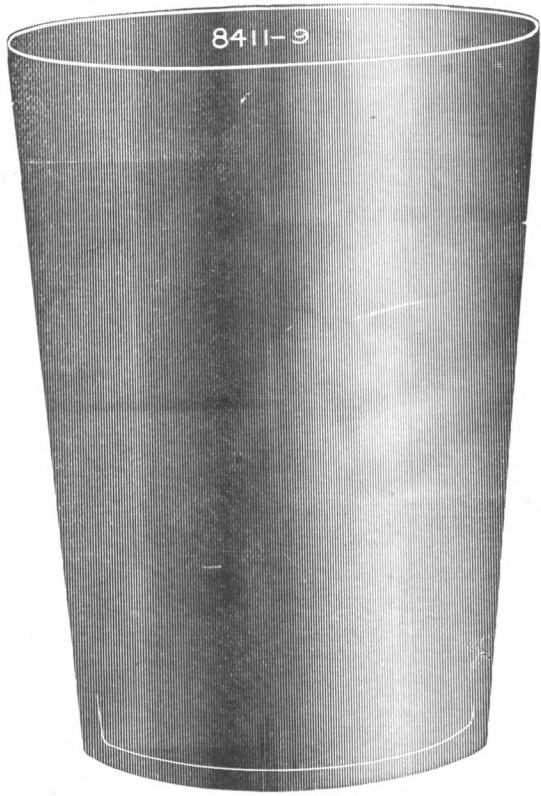
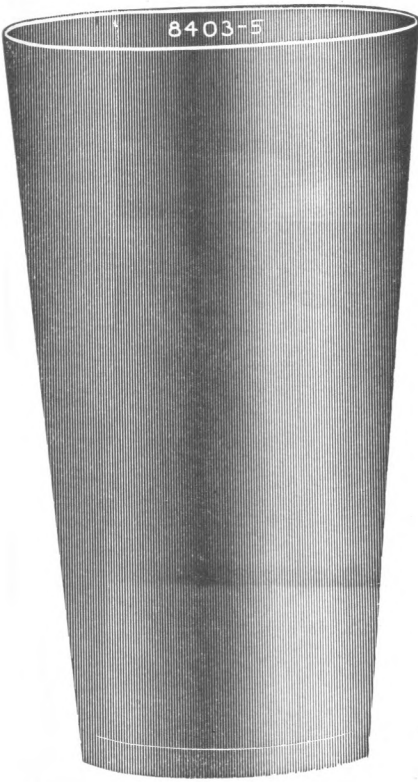

LEAD GLASS BLOWN TUMBLERS.

Unselected Quality, Unless Otherwise Ordered.

First Quality 33 1-3 per cent. Advance Over Unselected.

No.	Oz.		Price Dozen Plain	Price Dozen Optic	Price Dozen Punty	Doz. in Bbl.
8700	4½	Light Mineral	\$35	\$ 45	\$ 45	40
	5	"	35	45	45	35
8701	4	Light Straight Beer	33	43	43	45
✓	4½	"	35	45	45	40
✓	5	"	35	45	45	35
✓	6	"	36	46	46	28
✓	6½	"	37	47	47	26
✓	7	"	37	47	47	25
✓	7½	"	38	48	48	25
✓	8	"	38	48	48	20
	8½	"	42	52	52	20
✓	9	"	42	52	52	19
✓	10	"	42	52	52	18
✓	11	"	48	63	63	16
✓	11½	"	55	70	70	16
✓	12	"	55	70	70	15
✓	13	"	60	75	75	14
✓	14	"	70	85	85	14
	15	"	75	90	90	12
✓	16	"	82	97	97	12
	18	"	95	1 10	1 10	10
	20	"	1 15	1 30	1 30	10
	24	"	1 70	1 85	1 85	8
8702	4	Light Straight Beer	33	43	43	45
	4½	"	35	45	45	40
✓	5	"	35	45	45	35
✓	5½	"	36	46	46	34
✓	6	"	36	46	46	28
	6½	"	37	47	47	26
✓	7	"	37	47	47	25
	7½	"	38	48	48	25
✓	8	"	38	48	48	20
✓	8½	"	42	52	52	20
✓	9	"	42	52	52	20
✓	10	"	42	52	52	18
✓	11	"	48	63	63	16
✓	12	"	55	70	70	15
✓	13	"	60	75	75	14
✓	14	"	70	85	85	14
	15	"	75	90	90	12
✓	16	"	82	97	97	12
	18	"	95	1 10	1 10	10

Old Rochester Tumbler Company's numbers, shapes and sizes. Complete lines shown above can be had either in plain or optic. Cuts on opposite page actual size.

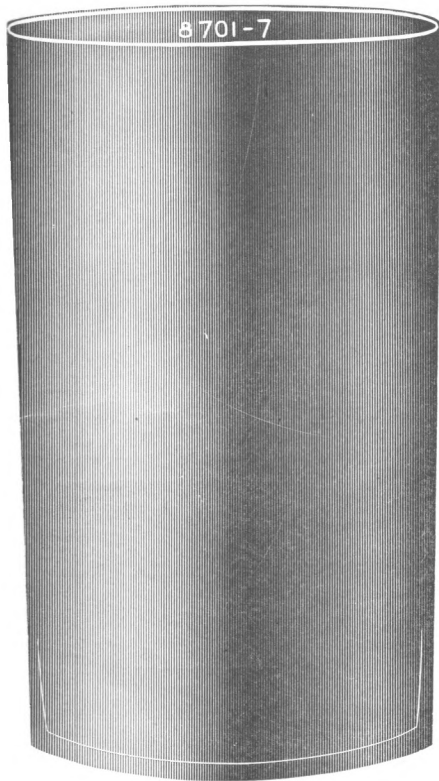

LEAD GLASS BLOWN TUMBLERS.

Unselected Quality, Unless Otherwise Ordered.
First Quality 33 1-3 per cent. Advance Over Unselected.

No.	Oz.		Price Dozen Plain	Price Dozen Optic	Price Dozen Punty	Doz. in Bbl.
8703	9	Light Straight Beer	\$ 42	\$ 52	\$ 52	18
	10	"	42	52	52	15
	10	" Handled	92	1 02	1 02	14
	10½	"	42	57	57	15
	11	"	48	63	63	14
	11½	"	55	70	70	14
	12	"	55	70	70	12
	13	"	60	75	75	12
8711	✓ 4	Medium Straight Beer	41	51	51	40
	✓ 4½	"	44	54	54	36
	✓ 5½	"	45	55	55	32
	✓ 6	"	45	55	55	28
	✓ 7	"	49	59	59	25
	✓ 7½	"	50	60	60	22
	✓ 9	"	54	64	64	20
	✓ 10	"	59	69	69	18
	✓ 11	"	65	80	80	14
	✓ 12	"	72	87	87	14
	✓ 13	"	77	92	92	12
	✓ 14	"	1 05	1 20	1 20	12
	✓ 15	"	1 10	1 25	1 25	12
	16	"	1 32	1 47	1 47	10
	18	"	1 45	1 60	1 60	10
8712	✓ 4½	Medium Straight Beer	44	54	54	35
	✓ 5	"	44	54	54	35
	✓ 6	"	45	55	55	32
	✓ 7½	"	50	60	60	24
	✓ 8	"	50	60	60	22
	✓ 8½	"	54	64	64	20
	✓ 9½	"	59	69	69	18
	✓ 10½	"	65	80	80	16
	✓ 12	"	72	87	87	16
	✓ 14	"	1 05	1 20	1 20	12
8801	6	Light Straight Ale	36	46	46	32
	6½	"	37	47	47	32
8802	10½	"	42	57	57	18
8803	10	"	42	52	52	15
	10	" Handled	92	1 02	1 02	14
8804	5½	Light Straight Ale	36	46	46	30
	7½	"	38	48	48	24
	8½	"	42	52	52	20
	9¼	"	42	52	52	19
	11	"	48	63	63	16

Old Rochester Tumbler Company's numbers, shapes and sizes. Complete lines shown above can be had either in plain or optic. Cuts on opposite page actual size.

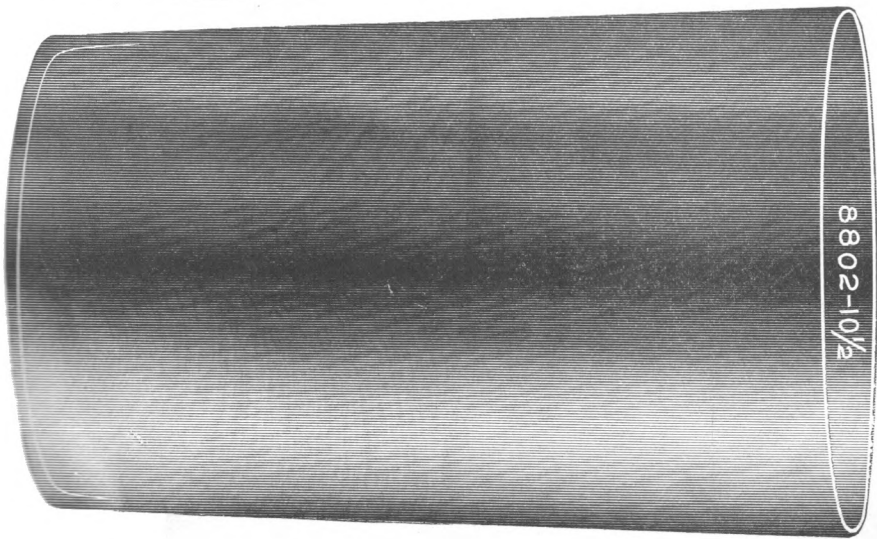
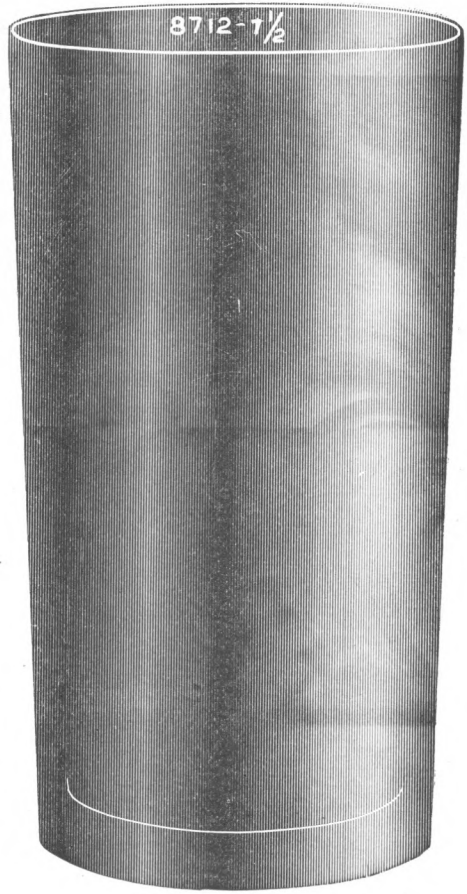

LEAD GLASS BLOWN TUMBLERS.

Unselected Quality, Unless Otherwise Ordered.

First Quality 33 1-3 per cent. Advance Over Unselected.

No.	Oz.		Price Dozen Plain	Price Dozen Optic	Price Dozen Punty	Doz in Bbl.
8806	8	Light Straight Ale	\$ 38	\$ 48	\$ 48	22
	14	"	70	85	85	14
8851	✓ 2½	Light Touraine	32	42	42	75
	✓ 3	"	32	42	42	70
	✓ 3¼	"	35	45	45	65
	✓ 3½	"	35	45	45	65
	✓ 4	"	35	45	45	50
	✓ 5	"	37	47	47	40
	✓ 6	"	39	49	49	35
	✓ 7	"	40	50	50	30
	✓ 8	"	41	51	51	30
	✓ 9	"	44	54	54	25
	✓ 10	"	45	55	55	25
	✓ 12	"	60	75	75	18
	✓ 14	"	80	95	95	15
8852	✓ 4	Light, Tall Touraine	35	45	45	36
	✓ 5	"	37	47	47	30
	✓ 6	"	39	49	49	25
	✓ 7	"	40	50	50	22
	✓ 7½	"	41	51	51	22
	✓ 8	"	41	51	51	20
	✓ 9	"	44	54	54	18
	✓ 10	"	45	55	55	15
8853	4	Light Touraine Soda	35	45	45	50
	5	"	37	47	47	40
	6	"	39	49	49	35
	7	"	40	50	50	30
	8	" Fits Holder	41	51	51	30
	10	"	45	55	55	25
	12	"	60	75	75	18
9000	2½	Light Bell Top	32	42	42	50
	3½	"	35	45	45	40
	4½	"	37	47	47	30
	6	"	39	49	49	25
	7	"	40	50	50	25
	8	"	41	51	51	22
	9½	"	45	55	55	16
	10½	"	60	75	75	14
	12	"	60	75	75	13

Old Rochester Tumbler Company's numbers, shapes and sizes. Complete lines shown above can be had either in plain or optic. Cuts on opposite page actual size.

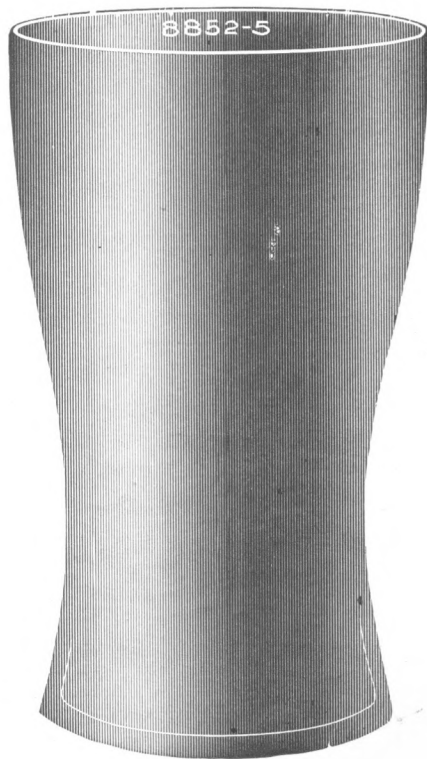

LEAD GLASS BLOWN TUMBLERS.

Unselected Quality, Unless Otherwise Ordered.

First Quality 33 1-3 per cent. Advance Over Unselected.

No.	Oz.		Price Dozen Plain	Price Dozen Optic	Price Dozen Punty	Doz. in Bbl.
9001	½	Bell, Communion	45	\$ 55	\$ 55	150
✓	1½	Light Bell Top	32	42	42	90
✓	2	"	32	42	42	70
✓	2½	"	32	42	42	65
✓	3	"	32	42	42	60
✓	4	"	35	45	45	40
✓	5	"	37	47	47	30
✓	6	"	39	49	49	25
✓	7	"	40	50	50	24
✓	8	"	41	51	51	20
✓	9	"	44	54	45	20
✓	10	"	45	55	25	16
✓	11	"	60	75	75	15
✓	12	"	60	75	75	13
9002	½	Bell Communion	45	55	55	150
✓	1	Light Bell Top	32	42	42	125
✓	1½	"	32	42	42	110
✓	2	"	32	42	42	90
✓	2½	"	32	42	42	85
✓	3	"	32	42	42	60
✓	4	"	35	45	45	45
✓	5	"	37	47	47	35
✓	6	"	39	49	49	30
✓	7	"	40	50	50	25
✓	8	"	41	51	51	20
✓	9	"	44	54	54	20
✓	10	"	45	55	55	16
✓	11	"	60	75	75	15
✓	12	"	60	75	75	15
✓	14	"	80	95	95	10
✓	16	"	1 00	1 15	1 15	9
✓	18	"	1 18	1 33	1 33	9
✓	20	"	1 35	1 50	1 50	8
9003	8	Light, Bell Soda	41	51	51	20
✓	9	"	44	54	54	18
✓	10	"	45	55	55	15
✓	11	"	60	75	75	30
✓	12	"	60	75	75	12
9009	8	Light Roll Top Soda	41	51	51	20
✓	10	"	45	55	55	14
✓	12	"	60	75	75	11

Old Rochester Tumbler Company's numbers, shapes and sizes. Complete lines shown above can be had either in plain or optic. Cuts on opposite page actual size.

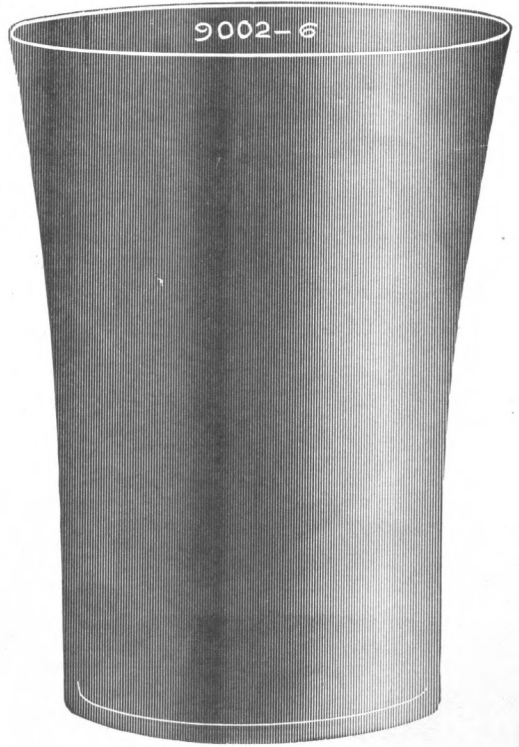

LEAD GLASS BLOWN TUMBLERS.

Unselected Quality. Unless Otherwise Ordered.

First Quality 33 1-3 per cent. Advance Over Unselected.

No.	Oz.		Price Dozen Plain	Price Dozen Optic	Price Dozen Punty	Doz. in Bbl.
9014	✓ 2½	Sham, Concave Bar	\$ 47	\$ 57	\$ 57	45
9015	✓ 1½	Sham Bell Top	47	57	57	100
	✓ 2	"	47	57	57	90
	✓ 2½	"	47	57	57	85
	✓ 3½	"	50	60	60	55
	✓ 4½	"	52	62	62	40
	✓ 5½	"	54	64	64	30
	✓ 6½	"	60	70	70	25
	✓ 7½	"	61	71	71	20
	✓ 8½	"	64	74	74	20
9016	✓ 1	Sham Bell Top	47	57	57	100
	✓ 1½	"	47	57	57	100
	✓ 2	"	47	57	57	90
	✓ 2½	"	47	57	57	85
	✓ 3	"	47	57	57	60
	✓ 3½	"	50	60	60	55
	✓ 4½	"	52	62	62	40
	✓ 5½	"	54	64	64	30
	✓ 6	"	54	64	64	28
	✓ 7½	"	61	71	71	20
	✓ 8	"	61	71	71	20
	✓ 9½	"	65	75	75	15
9021	✓ 2½	Light, Concave	32	42	42	50
	✓ 3	"	32	42	42	45
	✓ 4	"	35	45	45	35
	✓ 5	"	37	47	47	28
	✓ 6	"	39	49	49	22
	✓ 7	"	40	50	50	20
	✓ 7½	"	41	51	51	18
	✓ 8	"	41	51	51	18
	✓ 8½	"	44	54	54	18
	✓ 9	"	44	54	54	15
	✓ 10	"	45	55	55	15
	✓ 12	"	60	75	75	11
	✓ 16	"	1 00	1 15	1 15	9
9022	✓ 3	Light Concave	32	42	42	45
	✓ 4	"	35	45	45	35
	✓ 5	"	37	47	47	28
	✓ 6	"	39	49	49	22
	✓ 7	"	40	50	50	20
	✓ 8	"	41	51	51	18
	✓ 9	"	44	54	54	15
	✓ 10	"	45	55	55	15
	✓ 12	"	60	75	75	11
	✓ 14	"	80	95	95	10
	✓ 16	"	1 00	1 15	1 15	9

Old Rochester Tumbler Company's numbers, shapes and sizes. Complete lines shown above can be had either in plain or optic. Cuts on opposite page actual size.

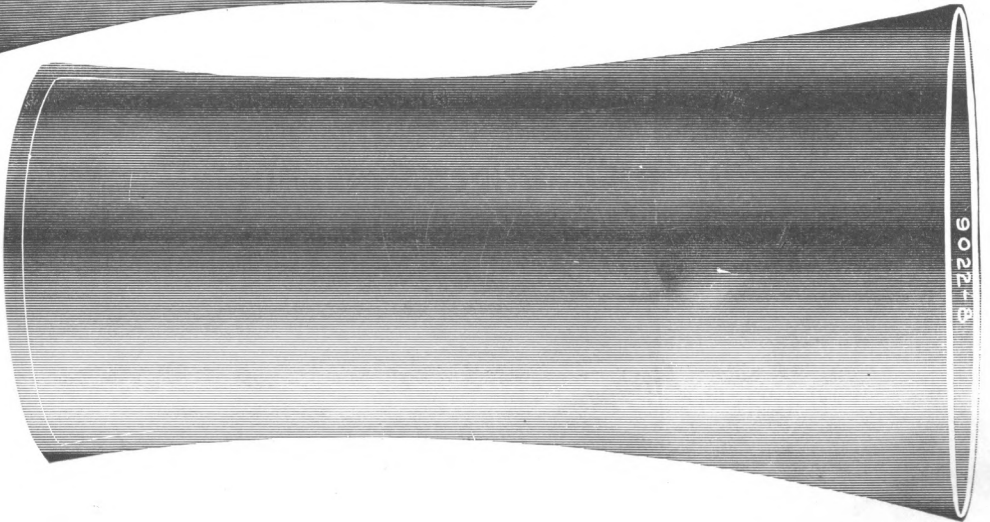
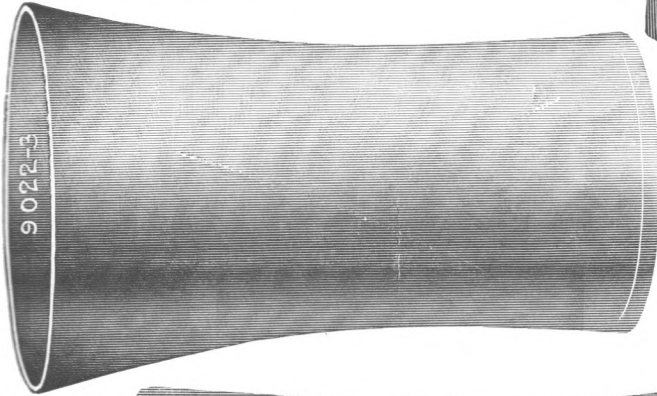

LEAD GLASS BLOWN TUMBLERS.

Unselected Quality, Unless Otherwise Ordered.
 First Quality 33 1-3 per cent. Advance Over Unselected.

No.	Oz.		Price Dozen Plain	Price Dozen Optic	Price Dozen Punty	Doz. in Bbl.
9023	4 1/2	Light, Concave	\$ 37	\$ 47	\$ 47	35
	5	"	37	47	47	30
	6	"	39	49	49	25
	7	"	40	50	50	20
	✓ 8	"	41	51	51	18
	9	"	44	54	54	16
	10	"	45	55	55	14
	11	"	60	75	75	14
13	"	68	83	83	11	
16	"	1 00	1 15	1 15	9	
9031	1 1/4	Medium, Bell Top	40	50	50	90
	1 3/4	"	40	50	50	70
	2 1/4	"	40	50	50	65
	2 3/4	"	40	50	50	60
	✓ 3 1/2	"	43	53	53	40
	✓ 4 1/2	"	46	56	56	30
	✓ 5 1/2	"	48	58	58	25
	✓ 6 1/2	"	52	62	62	24
	✓ 7 1/2	"	53	63	63	20
	✓ 8 1/2	"	56	66	66	16
✓ 9 1/2	"	62	72	72	16	
9032	3/4	Medium, Bell Top	40	50	50	125
	1 1/4	"	40	50	50	90
	1 3/4	"	40	50	50	70
	✓ 2 1/4	"	40	50	50	65
	✓ 2 3/4	"	40	50	50	60
	✓ 3	"	40	50	50	45
	✓ 3 1/2	"	43	53	53	45
	✓ 4 1/2	"	46	56	56	35
	✓ 5 1/2	"	48	58	58	30
	✓ 6 1/2	"	52	62	62	25
	✓ 7 1/2	"	53	63	63	20
	✓ 8 1/2	"	56	66	66	20
	✓ 9 1/2	"	62	72	72	16
9041	1 3/4	Medium Touraine	40	50	50	75
	2 1/4	"	40	50	50	70
	2 3/4	"	40	50	50	65
	3	"	40	50	50	65
	✓ 3 1/4	"	43	53	53	50
	✓ 3 3/4	"	43	53	53	40
	✓ 4 3/4	"	46	56	56	35
	✓ 5 1/2	"	48	58	58	30
	✓ 6 1/2	"	52	62	62	30
	✓ 7 1/2	"	53	63	63	25
	✓ 8 1/2	"	66	76	76	25
	✓ 9 1/2	"	62	72	72	18

Old Rochester Tumbler Company's numbers, shapes and sizes. Complete lines shown above can be had either in plain or optic. Cuts on opposite page actual size.

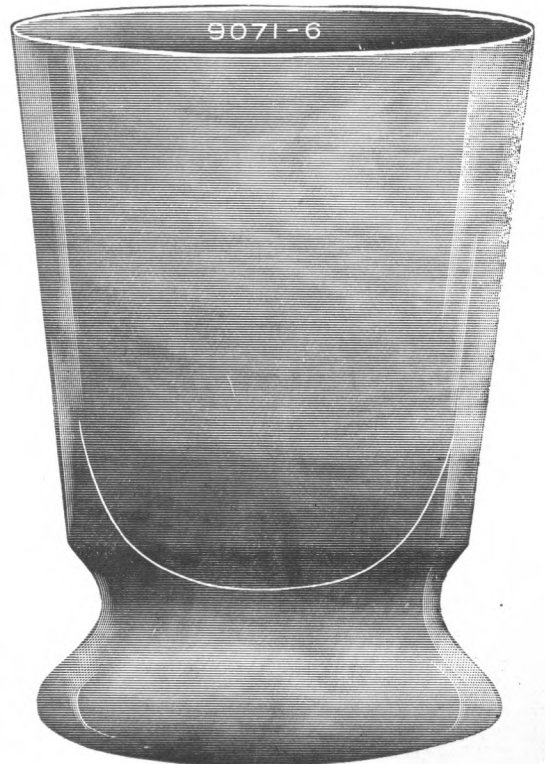
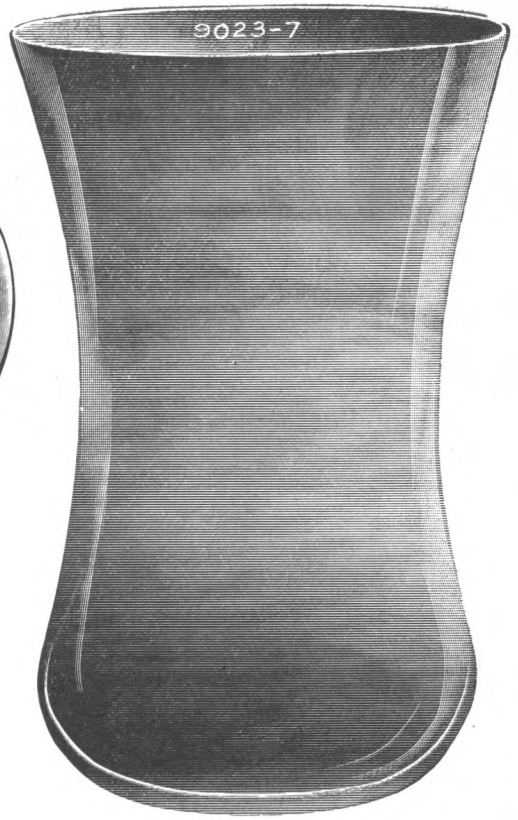

LEAD GLASS BLOWN TUMBLERS.

Unselected Quality, Unless Otherwise Ordered.

First Quality 33 1-3 per cent. Advance Over Unselected.

No.	Oz.		Price Dozen Plain	Price Dozen Optic	Price Dozen Punty	Doz. in Bbl.
9042	✓ 3½	Sham, Tall. Touraine	\$ 43	\$ 53	\$ 53	30
	✓ 4½	" <i>Line Ready</i>	46	56	56	25
	✓ 5½	"	48	58	58	22
	✓ 6½	" <i>See 125</i>	52	62	62	22
	✓ 7½	"	53	63	63	20
	✓ 8½	"	56	66	66	18
	✓ 9½	"	62	72	72	15
For Handles on 9042 Line, Add 50 cts. per Doz.						
9051	2½	Sham, Concave Bar	47	57	57	45
9061	✓ 10	Sham, Concave Ale	67	77	77	15
9070	✓ 6	Footed High Ball	1 00	1 15	1 15	18
9071	✓ 6	"	1 00	1 15	1 15	18
	✓ 7	"	1 00	1 15	1 15	18
9072	✓ 6	Stem, High Ball	1 00	1 15	1 15	18
	✓ 7	"	1 00	1 15	1 15	18
	✓ 8	"	1 00	1 15	1 15	18
9073	6	Stem, High Ball	1 00	1 15	1 15	18
	7	"	1 00	1 15	1 15	18
✓ 9301	✓ 4	✓ Light, Mineral	33	43	43	46
✓ 9302	5	"	35	45	45	35
9303	5½	"	36	46	46	30
9303	✓ 6	✓	36	46	46	28
✓ 9304	✓ 6½	"	37	47	47	28
✓ 9305	✓ 7	✓	37	47	47	25
9306	6½	"	37	47	47	25
	✓ 7	✓	37	47	47	25
	7½	"	38	48	48	25
9307	✓ 7	✓	37	47	47	25
9308	7½	"	38	48	48	22
✓ 9309	✓ 8	"	38	48	48	22
9310	✓ 8	✓	38	48	48	22
9311	✓ 7	"	37	47	47	25
9312	6	"	36	46	46	22
✓ 9313	7	"	37	47	47	22
9314	8	"	38	48	48	22
9401	8	Light Squat Beer	38	48	48	22
9402	9	Light Table	36	46	46	18
9403	✓ 9	"	36	46	46	20
9404	9	"	36	46	46	18
✓ 9405	✓ 9½	✓	36	46	46	18
9406	10	"	36	46	46	18
✓ 9407	11	Light Squat Beer	48	63	63	16
✓ 9408	15	"	75	90	90	12

Old Rochester Tumbler Company's numbers, shapes and sizes. Complete lines shown above can be had either in plain or optic. Cuts on opposite page actual size.

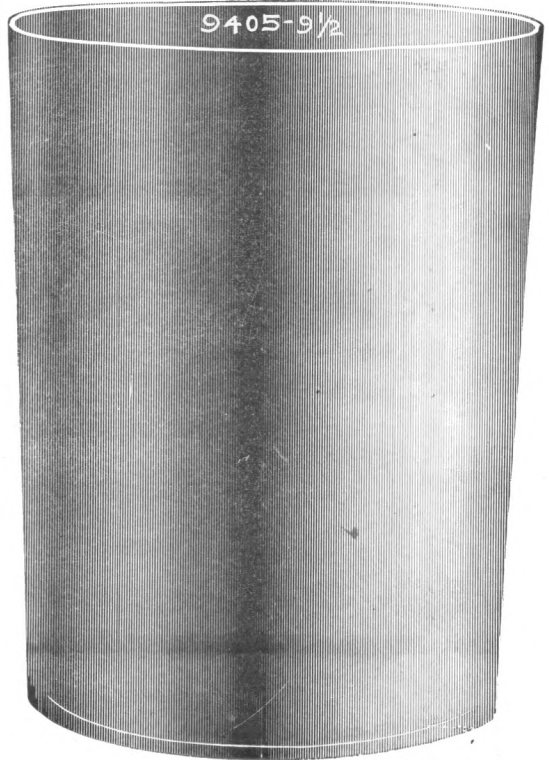
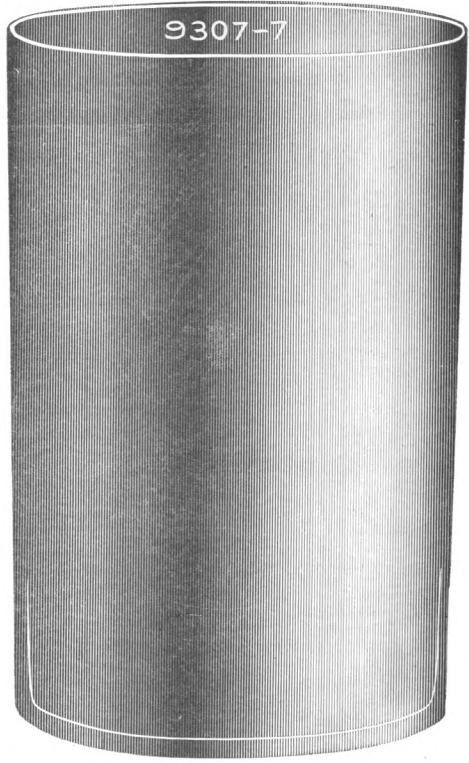

LEAD GLASS BLOWN TUMBLERS.

Unselected Quality, Unless Otherwise Ordered.

First Quality 33 1-3 per cent. Advance Over Unselected.

No.	Oz.		Price Dozen Plain	Price Dozen Optic	Price Dozen Punty	Doz in Bbl.
9409	9	Light Table	\$ 36	\$ 46	\$ 46	18
9410	10	Light Beer	45	55	55	18
	10½	"	48	58	58	18
9411	16	"	82	97	97	12
9412	17	"	90	1 05	1 05	9
9413	8	Light No Nest Hotel.....	45	55	55	22
	9	"	45	55	55	18
	10	"	45	55	55	18
9414	9½	Light Table	36	46	46	18
9415	✓ 9	" (0251).....✓	36	46	46	18
9416	9	Light Bell Top Table.....	44	54	54	20
9420	✓ 10	✓ Light Squat Beer.....	42	52	52	18
9448	5½	Medium Bar Water.....	45	55	55	30
9450	✓ 5½	✓ Sham Bar Water.....	51	61	61	30
✓ 9451	✓ 6	✓ Medium Bar Water.....	45	55	55	28
9452	7	"	49	59	59	25
9453	8	Medium Table.....	50	60	60	22
9454	8½	"	60	70	70	22
9455	✓ 9	✓ Sham Table.....✓	65	75	75	18
	9½	"	68	78	78	18
	10	"	68	78	78	18
9456	8	Medium Table.....	50	60	60	22
9457	9½	Sham Table.....	68	78	78	18
9471	✓ 9½	✓ Medium Table (0252).....✓	60	70	70	18
9476	6½	Sham Bar Water.....	57	67	67	28
9481	9	Double Thick Table.....	60	70	70	18
9482	9½	"	60	70	70	18
9483	10½	"	65	80	80	18
9484	8	Double Thick No. Nest Hotel.....	65	75	75	22
	9	"	65	75	75	18
	10	"	65	75	75	18
9485	10	Double Thick Table.....	65	75	75	18
9491	8	Light Round Bottom Table.....	40	50	50	22
	9	"	40	50	50	18
9492	12	Sham Round Bottom Table.....	80	95	95	16
9494	7½	"	55	65	65	21
	9	Medium Round Bottom Table.....	60	70	70	20

Old Rochester Tumbler Company's numbers, shapes and sizes. Complete lines shown above can be had either in plain or optic. Cuts on opposite page actual size.

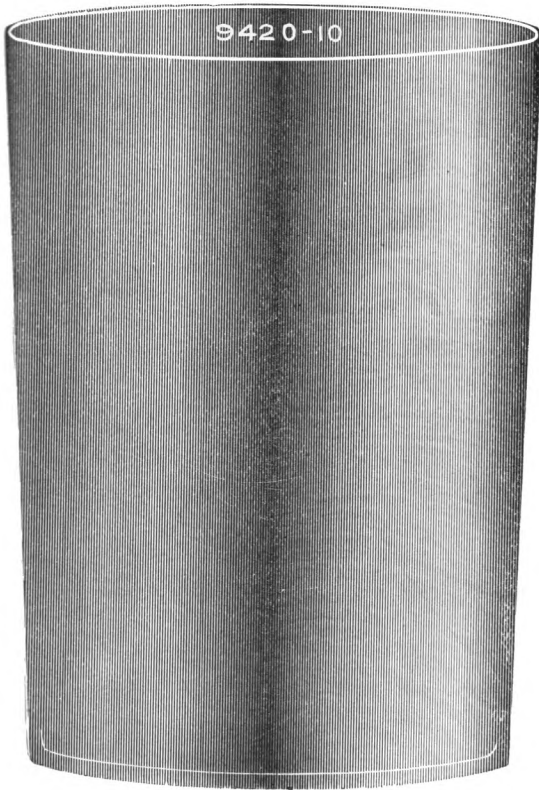
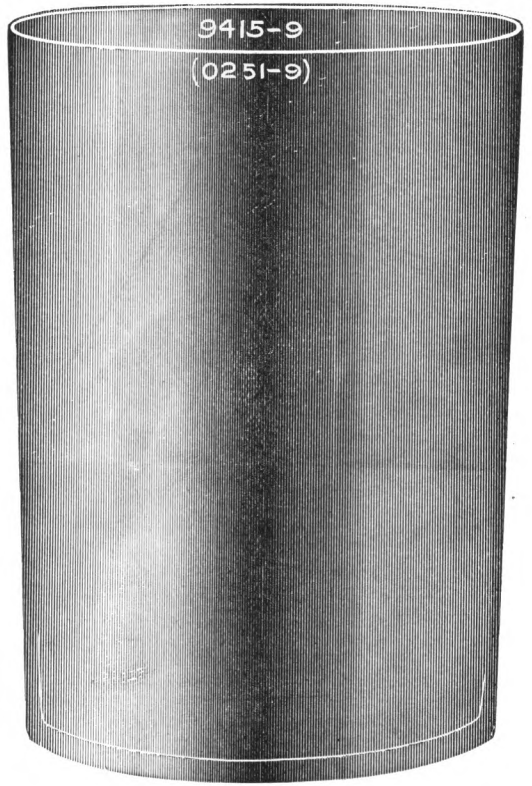
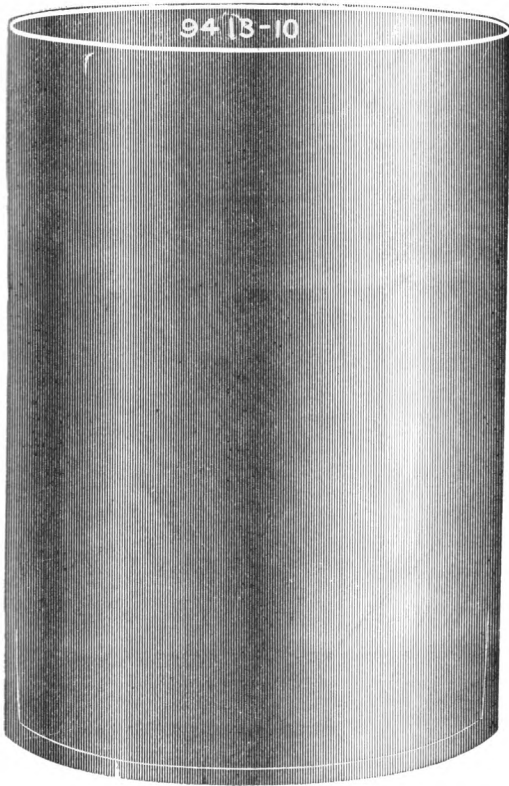

HANDLING BLOWN TUMBLERS.

For putting Stuck Handle on any Blown Tumbler, add 50c per Doz. to price. If article is not regularly made with Handle, a full turn must be ordered.

ADDITIONAL FOR SHAMMING TUMBLERS.

	Add per doz. Half Sham.	For Full Sham
To 4 oz.....	\$ 8	15
4½ to 6 oz.....	9	15
7 to 9 oz.....	12	20
10 to 13 oz.....	17	25
14 to 15 oz.....	35	45
12 to 19 oz.....	50	60
24 to 60 oz.....	65	1 00

FINGER BOWLS.

No.		Price Dozen Plain	Price Dozen Optic	Price Dozen Punty	Doz. in Bbl.
2924	Finger Bowl.....	\$1 00	\$1 25	\$1 20	15
2929	" Small.....	1 00	1 25	1 20	18
2926	" Medium.....	1 00	1 25	1 20	15
✓ 2928	" Large.....	1 00	1 25	1 20	15
2934	" Extra Large.....	1 00	1 25	1 20	15
2935	" Large.....	1 00	1 25	1 20	15
2937	" Hotel.....	1 00	1 25	1 20	15
2938	" Hotel.....	1 00	1 25	1 20	15
✓ 8851	" Touraine.....	1 40	1 65	1 60	15

SHERBETS.

✓ 2900	Handled Sherbets.....	80	95	1 00	30
2901	".....	80	95	1 00	30
✓ 2902	".....	80	95	1 00	28
✓ 2903	".....	80	95	1 00	28
2904	".....	80	95	1 00	30
2905	".....	80	95	1 00	35
2909	".....	80	95	1 00	30
2909	Oyster Cocktail.....	37	52	57	40
2910	Handled Custard.....	80	95	1 00	30
✓ 8851	".....	1 00	1 15	1 20	30
✓ 8851	Oyster Cocktail.....	39	54	59	40

Old Rochester Tumbler Company's numbers shapes and sizes. Complete lines shown above can be had either in plain or optic. Cuts on opposite page actual size.

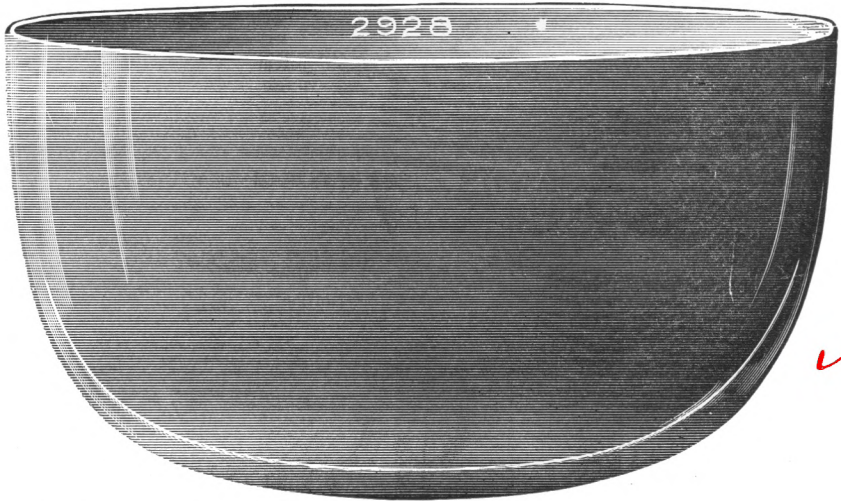

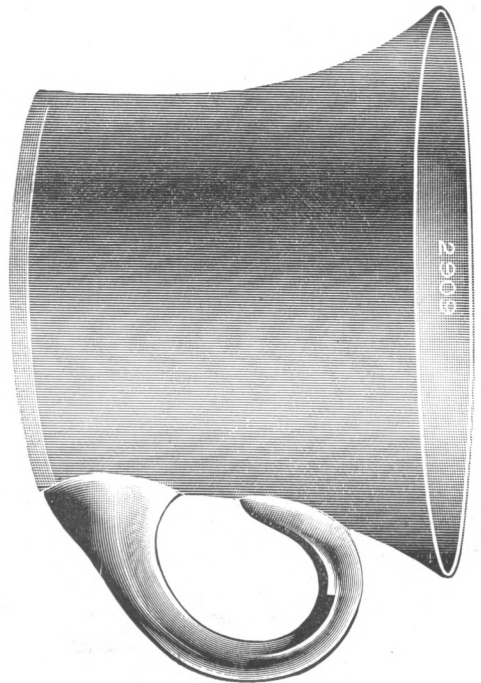
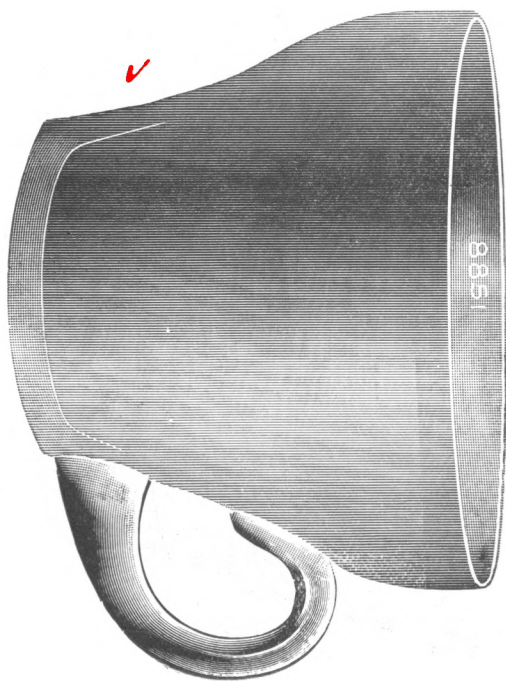
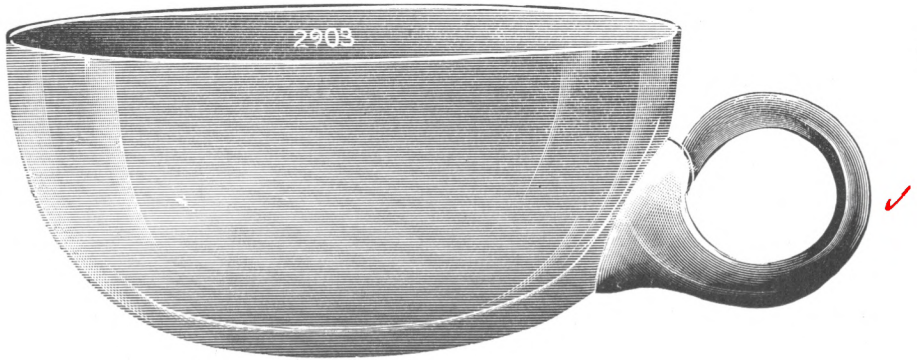
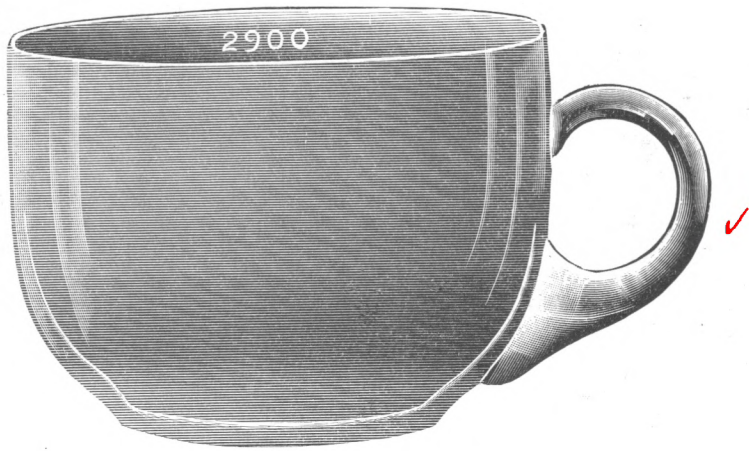

WHITE ENAMEL DECORATIONS.

Table Tumblers, any design shown, 44c per Dozen.

GOLD BANDS.

Gold Edge on Tumblers, 10 oz. of less.....	Add 15c per Doz.
Gold Edge on Tumblers, over 10 oz.....	Add 20c per Doz.
Gold Edge on Custards or Sherbets.....	Add 30c per Doz.
Gold Edge on Finger Bowls.....	Add 75c per Doz.
Other Bands on Tumblers, 10 oz. or less.....	Add 20c per Doz.
Other Bands on Tumblers, over 10 oz.....	Add 30c per Doz.
Other Bands on Custards or Sherbets.....	Add 65c per Doz.
Other Bands on Finger Bowls.....	Add \$1 Per Doz.

ENGRAVED No. 411.

Tumblers, Plain.....	Add 25c per Doz.
Tumblers, Handled.....	Add 35c per Doz.
Sherbets or Custards.....	Add 35c per Doz.
Finger Bowls.....	Add 75c per Doz.

ENGRAVED BANDS.

Engraved Bands No. 1 to No. 10 Inclusive.

On Tumblers.....	Add 5c per Doz.
On Finger Bowls.....	Add 10c per Doz.

COPPER WHEEL ENGRAVINGS.

For Copper Wheel Engravings Nos. 411, 419, 424, 432 or 475.

On Tumblers.....	Add 25c per Doz.
On Sherbets.....	Add 25c per Doz.
On Finger Bowls.....	Add 50c per Doz.
On Stem Ware.....	Add 30c per Doz.

COPPER WHEEL ENGRAVED LETTERS.

One Capital and nine Small Letters.....	Add 85c per Doz.
For each additional Capital.....	Add 45c per Doz.
For each additional small letter.....	Add 7c per Doz.
For each curved line.....	Add 50c per Doz.
For Wreath and one line name.....	Add \$3.20 per Doz.
For Wreath and two line name.....	Add \$4.00 per Doz.

NEEDLE ETCHINGS.

For any design shown.

On Tumblers, Plain.....	Add 25c per Doz.
On Tumblers, Handled.....	Add 35c per Doz.
On Sherbets or Custards.....	Add 35c per Doz.
On Finger Bowls.....	Add 75c per Doz.

DEEP PLATE ETCHED MONOGRAMS.

For Monograms.

On Tumblers.....	Add 55c per Doz.
On Handled Tumblers or Sherbets.....	Add 70c per Doz.
On Finger Bowls.....	Add \$1.00 per Doz.

LIGHT CUT BARS.

Lines No. 8101, 8102, 8103, 8104, 8105, 8107, 8111, 8112, 8120, 8201, and 8202, in below cuttings, take prices indicated for capacities designated.

Prices per Dozen.

	Cut 6 & 12	Cut 10, 11 & 60	Cut 15 & 16
To 3½ oz. inc,	\$ 50	Up to 4 oz. inc. \$ 80	\$1 00
Over 3½ oz. to 5 oz. inc.	53	Over 4 oz. to 4½ inc.	85 1 07
5½ oz.	68	Over 4½ oz. to 5½ inc.	92 1 10
Over 5½ oz. to 6½ oz. inc.	78	Over 5½ oz. to 6 inc.	97 1 16
		Over 6 oz. to 6½ inc.	97 1 20

Unselected and Not Puntied (N. P.) bottoms, 10 cents per Dozen less than above prices. For Optic add 10 cents per Dozen.

Bell or Touraine shape Tumblers in above cuttings, take same prices with the difference on price of blank added.

Old Rochester Tumbler Company's numbers, shapes and sizes. Complete lines shown above can be had either in plain or optic. Cuts on opposite page actual size.

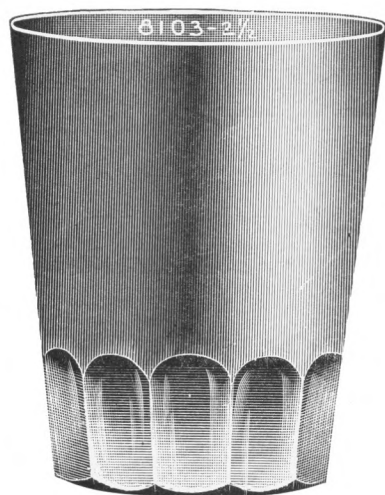
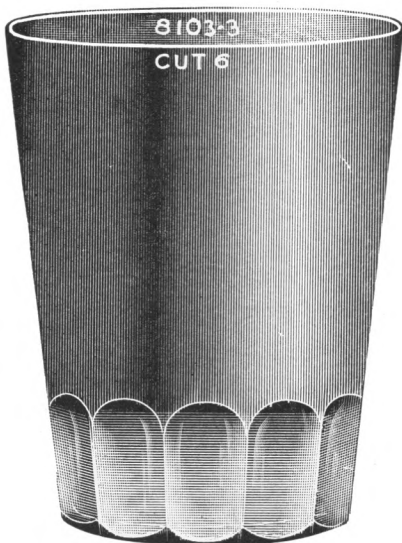
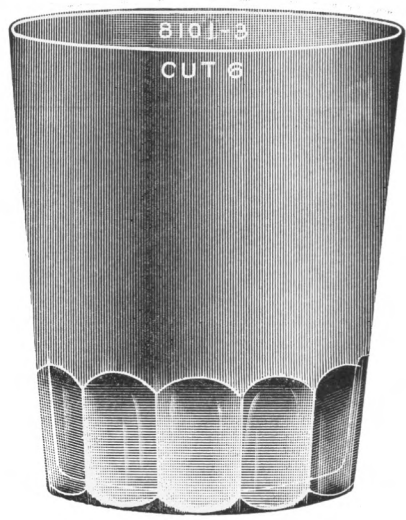

MEDIUM CUT BARS.

Lines No. 8121, 8122 and 8129 in below cuttings, take prices as indicated for capacities designated.

Prices per Dozen.

	Cut No. 20	Cut 6, & 12	Cut 10, 11 & 60	Cut 9, 14, 15, 16, 18½, 58 & 99½	Cut 4, 57½, 105 & 143
To 3½ oz. inclusive	\$ 93	\$ 63	\$ 83	\$1 08	\$1 28
3¾ oz.	93	69	83	1 08	1 28
4 oz.	93	69	83	1 08	1 28
4½ oz.	99	69	89	1 16	1 39
5 oz.	1 06	69	96	1 19	1 49
5½ oz.	1 06	74	96	1 19	1 69
6 oz.	1 11	94	1 01	1 25	1 80
6½ oz.	1 16	97	1 06	1 33	1 95

Unselected and Not Puntied (N. P.) bottoms, 10 cents per Dozen less than above prices. For Optic add 10 cents per Dozen.

Bell or Touraine shape Tumblers in above cuttings, take same prices with the difference in price of blank added.

SHAM CUT BARS.

Lines No. 8125, 8126, 8127, 8128, 8141 and 8142 in below cuttings, take prices as indicated for capacities designated.

Prices per Dozen.

	Cut 144	Cut 20	Cut 6 & 12	Cut 10, 11 & 60	Cut 9, 14, 15, 16, 18½, 58 & 99½	Cut 4, 57, 57½, 105, 105 & 143	Cut 59 & 108	Cut 145
To 3½ oz. inclusive	\$1 35	\$1 00	\$ 70	\$ 90	\$1 15	\$1 35	\$1 60	\$1 12
To 3¾ "	1 35	1 00	75	90	1 15	1 35	1 60	1 17
4 "	1 35	1 00	75	90	1 15	1 35	1 60	1 17
4½ "	1 50	1 05	75	95	1 22	1 45	1 75	1 32
5 "	1 50	1 12	75	1 02	1 25	1 55	1 85	1 40
5½ "	1 60	1 12	80	1 02	1 25	1 75	2 00	1 65

The above lines are made in Full Puntty Bottoms only.

For Optic add 10 cents per Dozen.

Bell or Touraine shape Tumblers in above cuttings, take same price with the difference in price of blank added.

SHAM CUT TODDY TUMBLERS.

Prices per Dozen.

No.	Oz.	Cut 6	Cut 9	Cut 10	Cut 20	Cut 14, 15, 18, 18½, 58 & 99½	Cut 4, 57, 57½, 105, & 107	Cut 106 108	Cut 109	Cut 144
8143	7 ✓	\$1 25	\$1 75	\$1 28	\$1 38	\$1 50	\$1 95	\$2 10	\$2 40	\$2 20
	9	1 50	2 25	1 46	1 56	1 70	2 10	2 40	2 75	2 50
8358	4	1 05	1 25	95	1 05	1 15	1 35	1 55	1 87	1 50
	5	1 10	1 50	1 07	1 17	1 25	1 55	1 70	2 00	1 75
	6 ✓	1 15	1 65	1 17	1 27	1 40	1 75	1 87	2 20	1 95

For Optic add 10 cents per Dozen.

Old Rochester Tumbler Company's numbers, shapes and sizes. Complete lines shown above can be had either in plain or optic. Cuts on opposite page actual size.

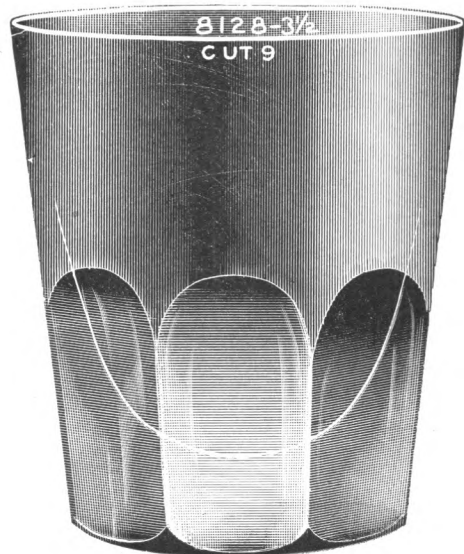
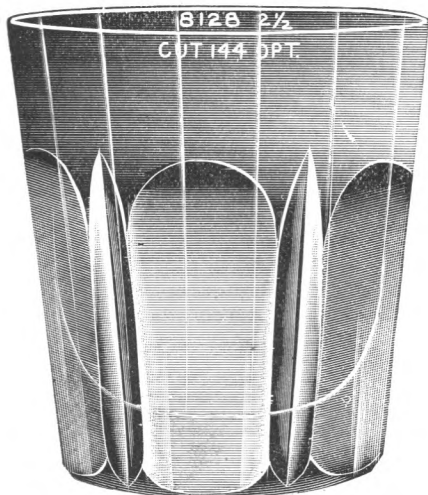
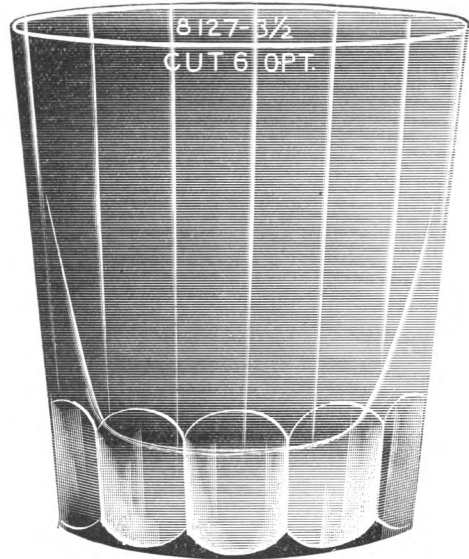
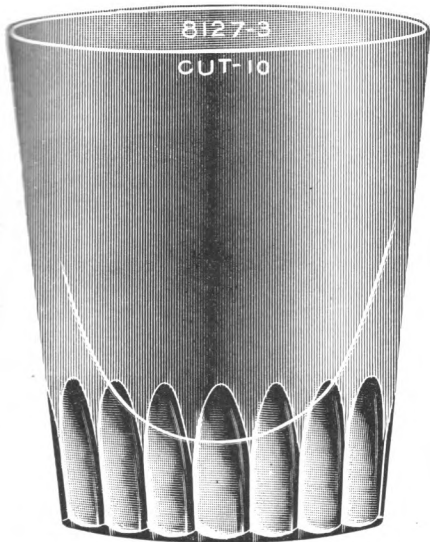
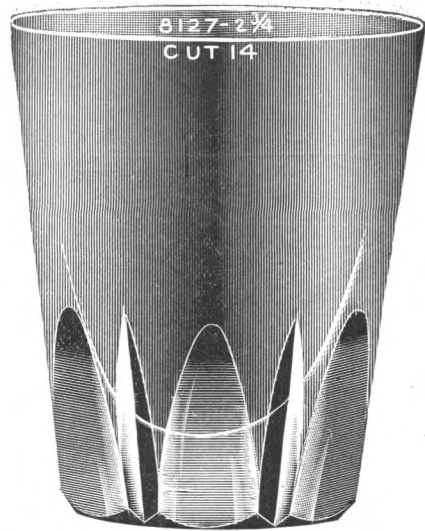

CUT FOOTED HIGH BALLS.

Prices per Dozen.

No.	Oz.	Cut 4	Cut 6	Cut 9	Cut 144
9070	6	\$2 50	\$1 65	\$2 05	\$2 50
9071 ✓	6	2 50	1 65	2 05	2 50
	7	2 50	1 65	2 05	2 50
9072 ✓	6	2 50	1 65	2 05	2 50
	7	2 50	1 65	2 05	2 50
9073	6	2 50	1 65	2 05	2 50
	7	2 50	1 65	2 05	2 50

For Optic add 15 cents per Dozen.

CUT BAR WATERS.

Prices per Dozen.

No.	Oz.	Cut 6 & 12	Cut 10, 11 & 60	Cut 20	Cut 9, 14, 15, 16, 18½, 58	Cut 4, 57, 57½, 105	Cut 106, 108	Cut 107	Cut 109 144
9448	5½ Medium	\$ 99	\$1 06	\$1 16	\$1 25	\$1 70	\$1 85	\$1 75	\$1 80
9450 ✓	5½ Sham	1 05	1 12	1 22	1 31	1 75	1 90	1 80	1 85
9451 ✓	6 Medium	99	1 06	1 16	1 25	1 70	1 85	1 75	1 80
9476	6½ Sham	1 11	1 18	1 28	1 37	1 81	1 96	1 86	1 91

For Optic add 10 cents per Dozen.

LIGHT CUT BEER AND SODA TUMBLERS.

Lines No. 8401, 8402, 8403, 8701 and 8702 in following cuttings, take prices indicated for capacities designated.

Prices per Dozen.

Oz.	Cut 6 & 12	Cut 10, 11 & 60	Cut 15 & 16	Cut 57 & 57½
3	\$ 60	\$ 80	\$1 00	\$1 20
3½	65	80	1 00	1 20
4	65	80	1 00	1 20
4½	65	85	1 07	1 30
5	65	92	1 10	1 40
5½	70	92	1 10	1 60
6	90	97	1 16	1 60
7	95	1 03	1 25	1 68
8	1 00	1 08	1 30	1 83
9	1 05	1 15	1 40	1 88
10	1 10	1 21	1 45	1 93
11	1 25	1 32	1 50	1 93
12	1 30	1 38	1 55	2 03
13	1 40	1 48	1 65	2 18
14	1 45	1 54	1 70	2 18
15	1 55	1 65	1 80	2 25
16	1 65	1 75	1 95	2 25
18	1 80	1 90	2 10	2 40
20	2 05	2 00	2 30	2 65
21	2 25	2 15	2 40	2 80

Unselected and Not Puntied (N. P.) Bottoms, 10 cents per Dozen less than above prices.

Old Rochester Tumbler Company's numbers, shapes and sizes. Complete lines shown above can be had either in plain or optic. Cuts on opposite page actual size.

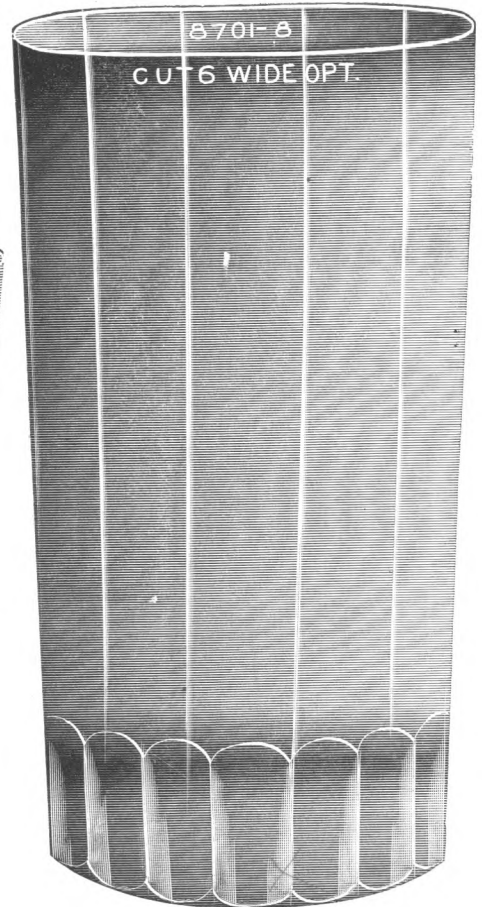
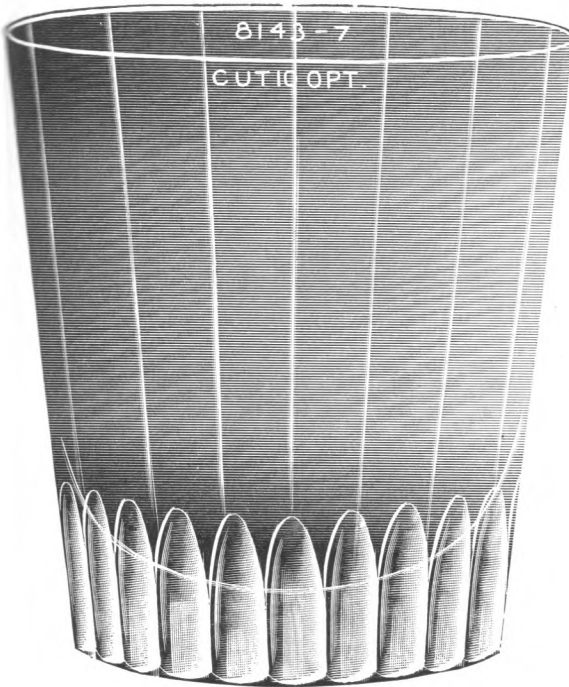
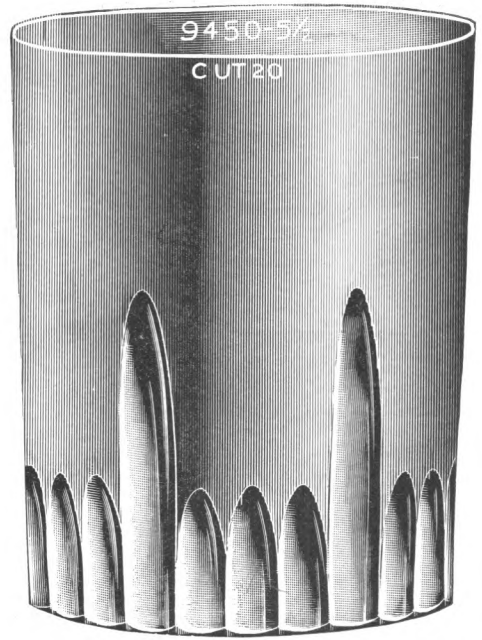
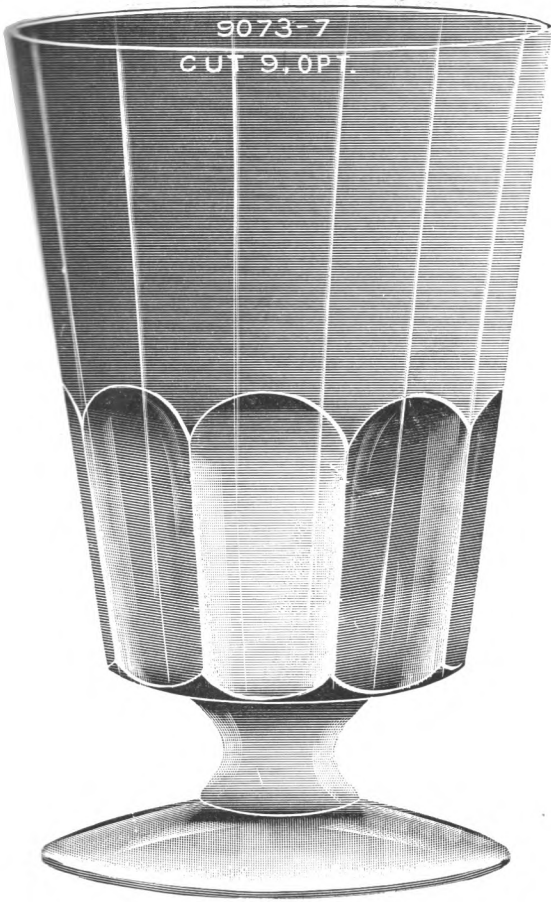

LIGHT CUT MINERALS, Etc.

Prices per Dozen.

No.	Oz.	Cut 6 & 12	10, 11 & 60	15 & 16
9301	4	\$ 65	\$ 80	\$1 00
9302	5	65	92	1 10
9303 ✓	6	90	97	1 16
9304	6½	90	97	1 20
5305 ✓	7	95	1 03	1 25
9306 ✓	7	95	1 03	1 25
9307 ✓	7	95	1 03	1 25
9308	7½	1 00	1 03	1 25
9309 ✓	8	1 00	1 08	1 30
9310 ✓	8	1 00	1 08	1 30
9311 ✓	7	95	1 03	1 25

Unselected and Not Puntied (N. P.) Bottoms, 10 cents per Dozen less than above prices.

MEDIUM CUT MINERALS, Etc.

Lines No. 8711 and 8712 in below cuttings, take prices as indicated for capacities designated.

Prices per dozen.

Oz.	Cut 505	Cut 6 & 12	Cut 10, 11 & 60	Cut 9, 14, 15, 16, 18, 18½, 58 & 99½	Cut 4, 57, 57½, 105 & 107	Cut 143	Cut 106 & 108	Cut 144	Cut 145	Cut 29
4	\$3 10	\$ 74	\$ 88	\$1 08	\$1 60	\$1 25	\$1 87	\$1 50	\$1 28	\$2 00
4½	3 25	74	94	1 16	1 60	1 30	1 87	1 55	1 28	2 00
5	3 25	74	1 01	1 19	1 70	1 30	1 87	1 65	1 34	2 15
5½	3 40	79	1 01	1 19	1 70	1 35	1 87	1 65	1 39	2 15
6	3 40	99	1 06	1 25	1 70	1 35	1 87	1 70	1 39	2 15
6½	3 50	1 02	1 06	1 32	1 80	1 45	1 95	1 75	1 56	2 25
7	3 50	1 07	1 15	1 37	1 80	1 55	1 95	1 75	1 56	2 25
7½	3 65	1 12	1 20	1 42	1 95	1 55	2 10	1 80	1 56	2 25
8	3 65	1 12	1 20	1 42	1 95	1 55	2 10	1 90	1 56	2 35
9	3 75	1 17	1 27	1 52	1 95	1 70	2 10	2 00	1 78	2 35
10	3 75	1 27	1 38	1 62	2 10	1 80	2 30	2 05	1 78	2 50
11	3 90	1 42	1 49	1 67	2 10	1 90	2 30	2 20	2 34	2 50
12	3 90	1 47	1 55	1 72	2 20	1 90	2 45	2 35	2 34	2 75
13	4 20	1 57	1 65	1 82	2 35	2 00	2 60	2 65	2 77	3 10
14	4 20	1 80	1 89	2 05	2 50	2 20	2 70	2 85	2 77	3 25
15	4 50	1 90	2 00	2 15	2 60	2 35	2 85	3 00	3 17	3 50
16	4 50	2 15	2 25	2 45	2 60	2 60	2 85	3 10	3 17	3 70

For Optic to 10 oz. inclusive, add 10c.; over 10 oz. add 15 cents per Dozen.

Cut No. 20 is 10 cents per Dozen higher than Cut No. 10 on same capacity.

Bell or Touraine shape Tumbler in above cuttings, take same prices with the difference in price of blank added.

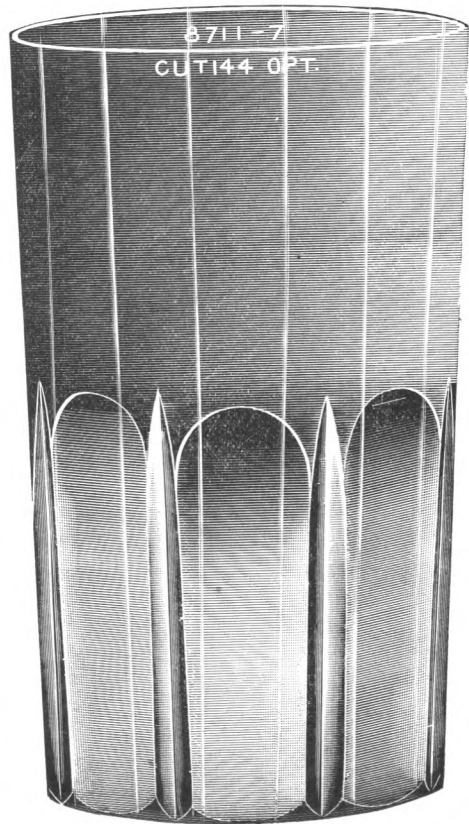
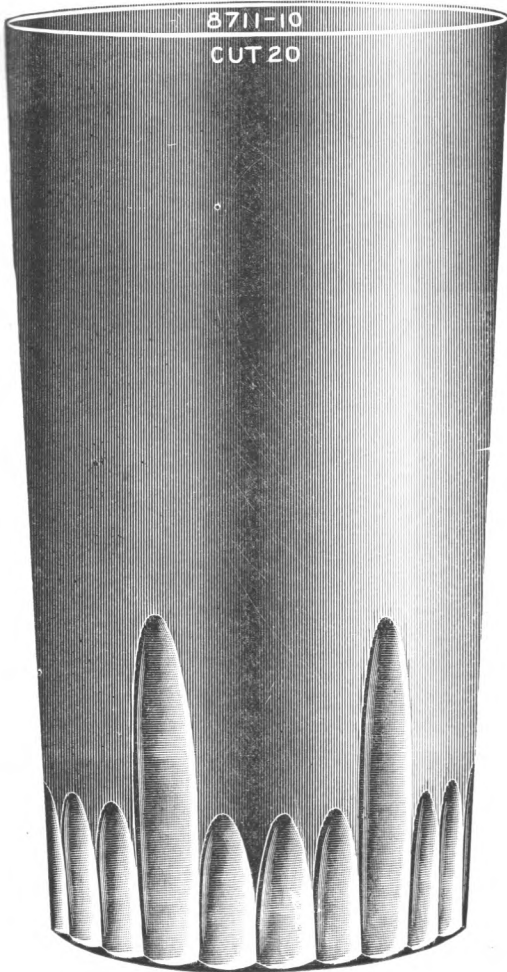
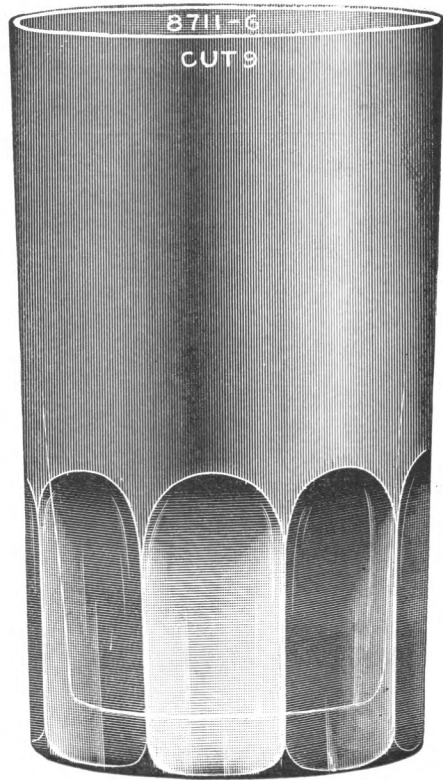
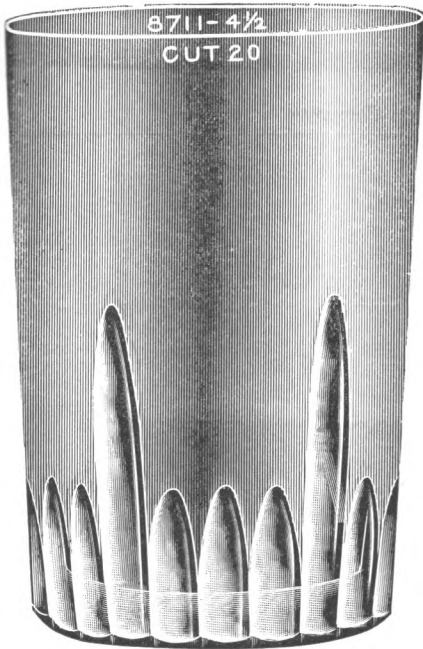

MISCELLANEOUS LIGHT CUTTINGS.

	Prices per Dozen			
	9403—9	9001—8	8401—5	8101—3
✓ Cut	9415—9	8851—9	8402—5	8103—3
✓ 6	\$ 93	\$1 03	\$ 65	\$ 60
10	1 15	1 25	92	80
✓ 12	93	1 03	65	60
15	1 45	1 55	1 10	1 00
16	1 45	1 55	1 10	1 00
19	86	1 00	90	80
✓ 57	1 50	1 88	1 40	1 20
✓ 57½	1 50	1 88	1 40	1 20
✓ 73	2 75	2 75	2 50	2 25
✓ 90	2 45	2 45	2 20	1 95
100	3 00	3 00	2 75	2 50
✓ 121	1 85	1 85	1 65	1 50
✓ 122	2 25	2 25	2 05	1 90
✓ 123	1 85	1 85	1 65	1 50
✓ 124	1 85	1 85	1 65	1 50
✓ 125	2 00	2 00	1 85	1 70

All above are priced for punty bottoms except Cuts 121 and 122.
For Optic add 10 cents per Dozen.

MISCELLANEOUS HEAVY CUTTINGS.

	9471—9	9455—9	9031—8½	8421—4½	8127—3½
✓ Cut	\$1 80	\$1 85	9041—8½	\$1 45	\$1 35
✓ 4	1 25	1 30	\$1 80	80	75
✓ 6	1 65	1 75	1 25	1 25	1 15
✓ 9	1 35	1 40	1 35	1 07	95
✓ 10	1 45	1 50			
✓ 10½	1 45	1 50			
✓ 12	1 25	1 30		80	75
✓ 14	1 65	1 75		1 25	1 15
✓ 15	1 65	1 75	1 65	1 25	1 15
✓ 16	1 65	1 75	1 65	1 25	1 15
✓ 18	1 65	1 75		1 25	1 15
✓ 18½	1 65	1 75	1 65	1 25	1 15
✓ 19	1 10	1 15	1 10	1 05	95
✓ 28	2 00	2 25	2 00	2 00	1 80
✓ 29	2 25	2 50	2 25	2 25	2 00
✓ 57	1 80	1 85	1 80	1 55	1 35
✓ 57½	1 80	1 85	1 80	1 55	1 35
✓ 58	1 65	1 75		1 25	1 15
✓ 60	1 35	1 40		1 07	95
✓ 73	3 00	3 05	3 00	2 75	2 50

Miscellaneous Heavy Cuttings continued on page 45.

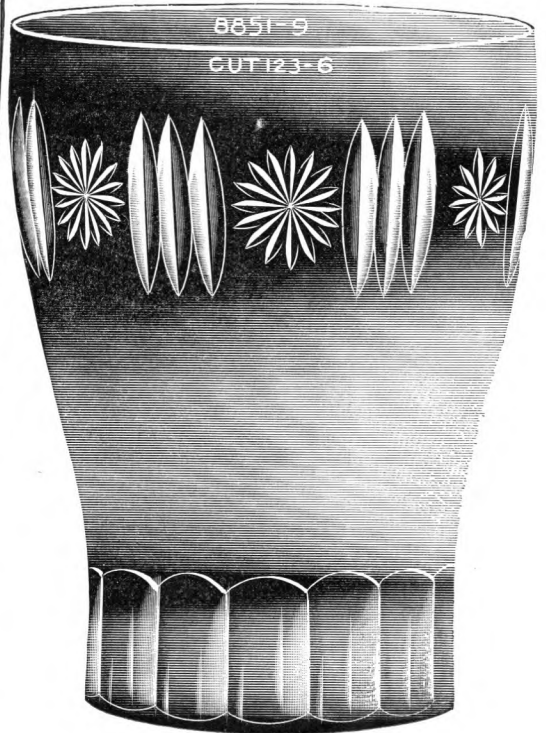
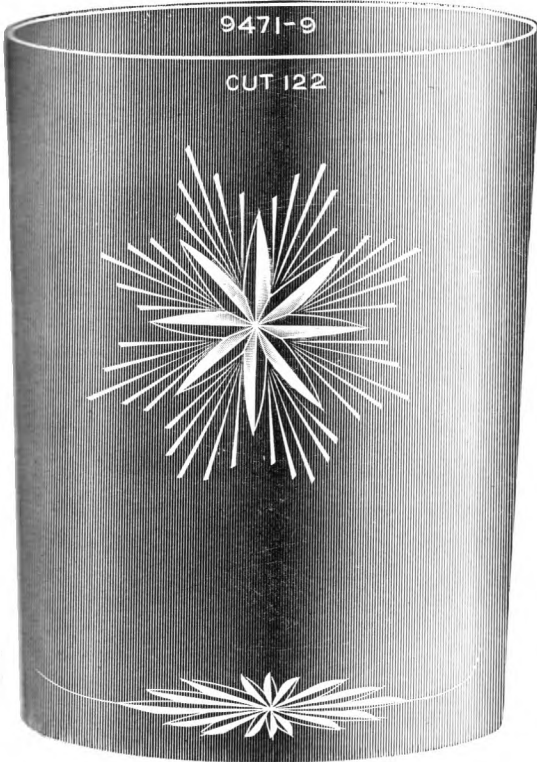
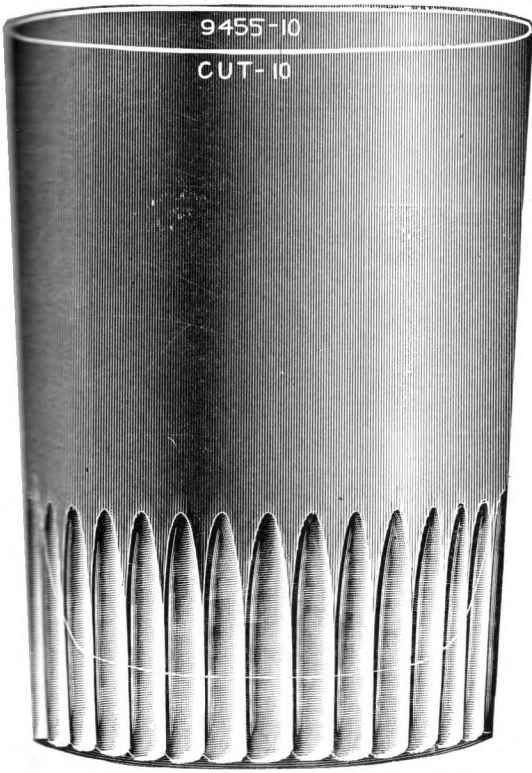

MISCELLANEOUS HEAVY CUTTINGS.

Prices per Dozen.

Cut	9471—9	9455—9	9031—8½ 9041—8½	8421—4½	8127—3½
108		\$2 15		\$1 90	\$1 60
✓ 121	\$1 95	2 00	\$1 95	1 80	1 65
✓ 122	2 35	2 40	2 35	2 20	2 05
✓ 123	2 00	2 25	2 00	2 00	2 00
124	2 00	2 25	2 00	2 00	2 00
✓ 125	2 00	2 25	2 00		
143	1 80	1 90	1 80		
✓ 144		2 24		1 75	1 50
145		2 50		1 45	2 25
				8426—9½	8425—9
151				2 75	
152				3 00	
157				4 65	
158				4 85	
160				4 50	
164		2 75		4 00	
✓ 173		5 50			5 75
195		4 75			
201		4 50		4 25	
202		3 50		4 25	
203		4 00			
204		3 75		4 00	
205		3 50			
206					4 00
207				4 65	
208					3 75
214	2 00				
216	2 65	2 75			
217				3 00	
220				5 30	
222					5 50
223	2 75			3 00	
224	2 50			2 75	
225				2 75	
226	1 90				
227	2 00				
228	2 50				
229	3 25				
230					5 00
233	3 85	4 00		4 25	
497		3 25			
499		3 25			
✓ 505	3 25	3 30	3 25		
506		3 50			
508		3 75			
509	1 45	1 50			
512	2 25	2 30	2 25		
✓ 545	3 75	3 80	3 75		

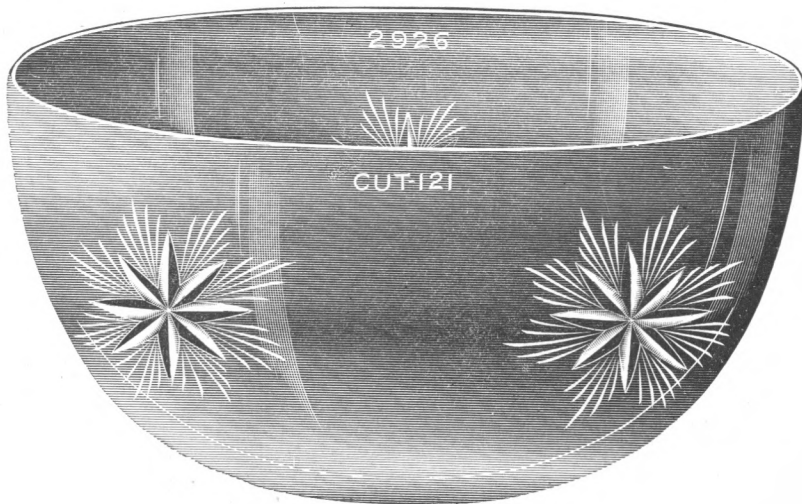
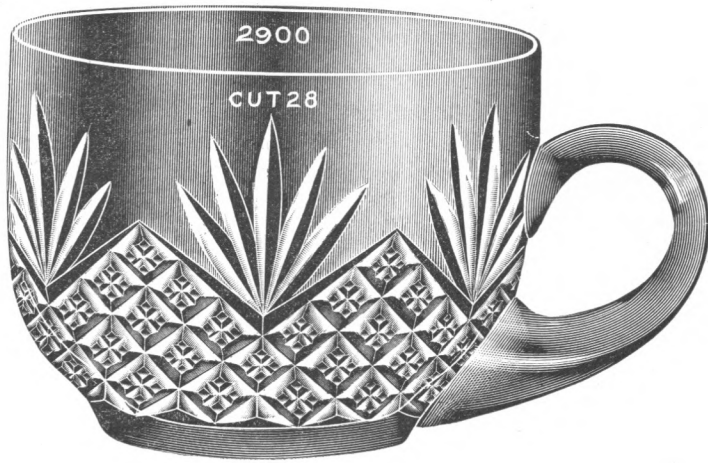

CUT SHERBETS AND FINGER BOWLS.

Cut	<i>Sherbets</i>		<i>Finger Bowls</i>	
	Nos. 2900, 2901, 2902, 2903, 2905, 2909		Nos. 2926, 2928, 2935	
✓ 6	\$1 25		\$1 70	
✓ 9	2 25		3 50	
✓ 10	1 40		1 95	
✓ 11	1 40		1 95	
✓ 14	1 70		2 05	
✓ 15	1 95		2 30	
✓ 16	1 70		2 30	
✓ 18	2 00		2 50	
✓ 19	1 55		1 90	
✓ 21	2 20		2 85	
✓ 29	2 25		3 85	
✓ 39	2 50		3 15	
✓ 57	1 95		2 75	
✓ 73	3 05		4 70	
✓ 90	2 50		4 15	
✓ 93	2 75		4 40	
✓ 100	3 05		4 60	
✓ 121	2 20	Punt, 2 00 Post	2 75	
✓ 122	2 75		3 65	
✓ 123	2 50		4 00	
✓ 144	2 50		*4 00	
✓ 214	2 75		3 65	
✓ 226	2 25		3 25	
✓ 227	2 75		3 65	
✓ 227½	2 20		2 75	
✓ 228	2 75		3 65	
✓ 503	2 00		3 00	
✓ 505	3 25		4 75	
✓ 507	2 50		4 00	
✓ 509	2 50		3 25	
✓ 511	2 50		4 00	
✓ 512	2 50		3 75	
✓ 545	3 75		5 25	

*on 8851 only.

Optic Sherbets, add 15 cents dozen.

Optic Finger Bowls, add 25 cents dozen.

Note:—Cut No. 509 on No. 8851 Finger Bowl, \$3.65 per Dozen.

CUT No. 17---COLONIAL.

8359	3	oz. Whiskey.....	\$2 00
8423	4	Champagne.....	2 25
8423	7	Beer.....	2 40
8423	9	Lemonade.....	2 50
8425	9	Table.....	2 50
8360	3½	Whiskey.....	2 00
8751	5	Champagne.....	2 25
8751	7	Beer.....	2 40
8751	9	Lemonade.....	2 50
9458	9	Table.....	2 50

LEAD GLASS BLOWN STEMWARE.

No.	Oz.		Price Dozen Plain	Price Dozen Optic	Doz. in Bbl.
10	3	Cocktail.....	\$ 70	\$ 85	25
36	6½	Pony Beer.....	80	95	16
	9	Beer Goblet.....	90	1 05	11
	10	Beer Goblet.....	90	1 05	10
53	3½	Cocktail.....	70	85	25
300	9	Goblet Touraine.....	1 10	1 25	12
	7	" ".....	1 10	1 25	12
	6	Champagne, Touraine.....	1 05	1 20	16
	5	Saucer Champagne, Touraine.....	1 25	1 40	10
	5½	Claret, Touraine.....	1 00	1 15	18
	4	Claret, Touraine.....	1 00	1 15	20
	4½	Sherbet, Touraine.....	1 00	1 15	20
	5	Sherbet, Saucer Foot, Touraine.....	1 40	1 55	15
	6½	Ice, Saucer Foot, Touraine.....	1 40	1 55	14
	4½	Egg, Touraine.....	1 00	1 15	20
	4	Oyster Cocktail, Touraine.....	1 00	1 15	20
	2½	Cocktail, Touraine.....	1 00	1 15	28
	3	" ".....	1 00	1 15	25
	3½	" ".....	1 00	1 15	25
	2½	Wine, Touraine.....	1 00	1 15	30
	3	" ".....	1 00	1 15	28
	2	Creme de Menthe, Touraine.....	1 00	1 15	28
	1¾	" ".....	1 00	1 15	30
	1¾	Sherry, Touraine.....	1 00	1 15	30
	1	Cordial, Touraine.....	90	1 05	60
	1	Pousse Cafe, Touraine.....	90	1 05	60
	¾	Brandy, Touraine.....	90	1 05	75
301	10	Goblet, Short Stem, Touraine.....	1 00	1 15	10
	7	" ".....	1 00	1 15	16
7402	10	High Ball.....	90	1 05	10
	8	" ".....	90	1 05	12
7452	6	Ale.....	95	1 10	15
7501	6	Champagne.....	80	95	16
7502	10½	Goblet.....	90	1 05	10
	8	" ".....	90	1 05	12
7503	11	" " Touraine.....	1 00	1 15	10
7504	6	Ale.....	95	1 10	15
7505	10½	Goblet.....	90	1 05	10
7506	6	Bell Ale.....	95	1 10	13

No.	Oz.		Price Dozen Plain	Price Dozen Optic
7516	10	Goblet.....	\$1 00	\$1 15
	8	" ".....	90	1 05
	6½	" ".....	80	95
	5½	Tall Champagne.....	80	95
	5	Claret.....	80	95
	4½	Rhine Wine.....	80	95
	1¾	Sherry.....	75	90
	1	Cordial.....	70	85
	1	Pousse Cafe.....	70	85
	3½	Cocktail.....	70	85
	5	Saucer Champagne.....	90	1 05
	5	Sherbet.....	80	95

Old Rochester Tumbler Company's numbers, shapes and sizes. One piece drawn stems. Cuts shown actual size. Complete lines made both plain and optic.

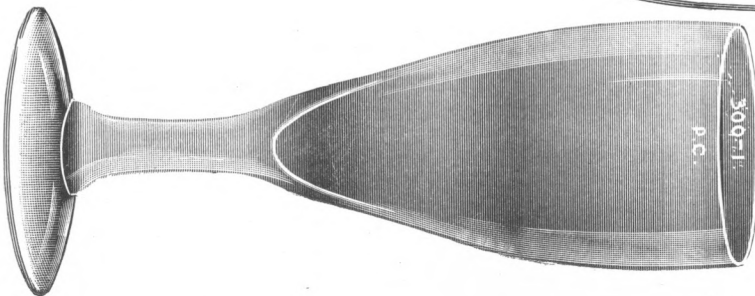
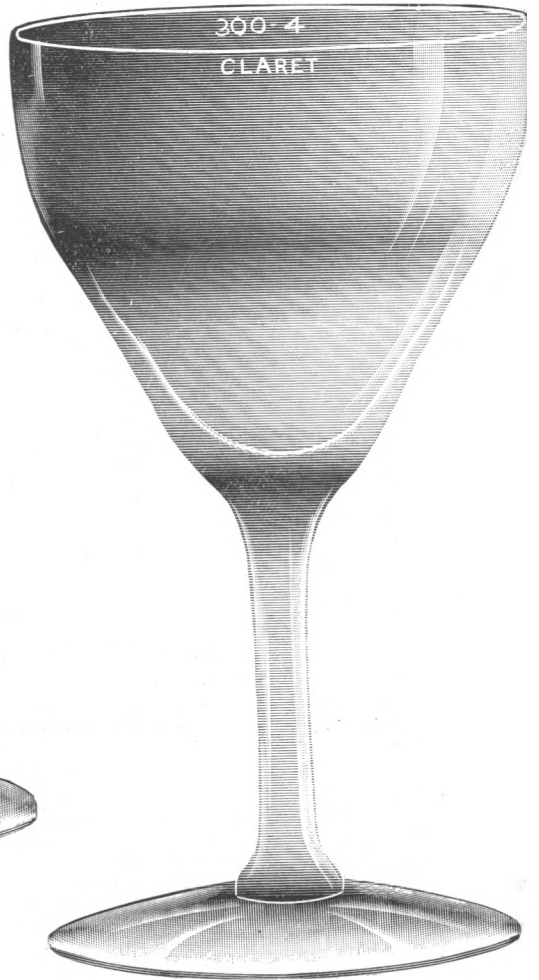

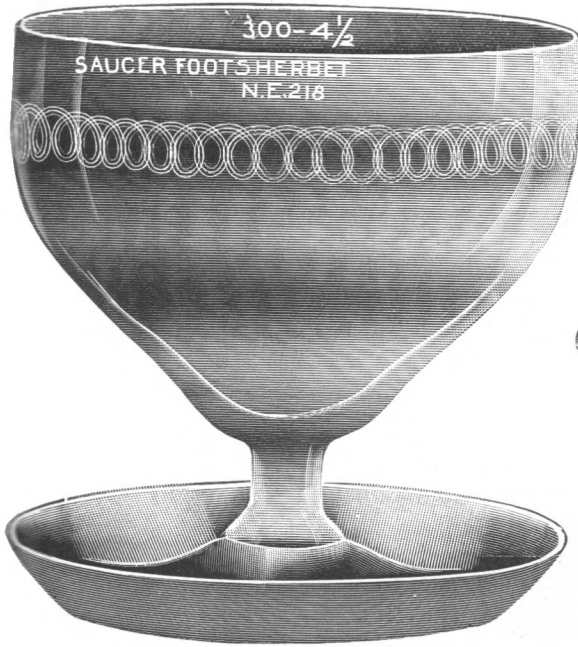

LEAD GLASS BLOWN STEMWARE.

No.	Oz.		Price Dozen Plain	Price Dozen Optic	Doz. in Bbl.
7516	✓ 6½	Champagne.....	\$ 80	\$ 95	15
	✓ 8	Goblet.....	90	1 05	13
	✓ 11	"	95	1 10	10
7517	9	"	90	1 05	10
7518	10½	"	90	1 05	10
7550	✓ —	5 inch Almond Stand.....	2 00	2 15	5½
7551	✓ —	Individual Almond.....	75	90	33
7552	—	Compote.....	1 50	1 65	18
7553	5	Sherbet.....	80	95	18
7779	✓ 10	Goblet.....	90	1 05	10
	9½	Goblet.....	90	1 05	10
	8	Goblet.....	90	1 05	12
	6	Champagne.....	80	95	16
	5	Saucer Champagne.....	90	1 05	12
	5	Claret.....	80	95	20
	4	Claret.....	80	95	22
	3	Cocktail.....	70	85	25
	3	Wine.....	75	90	30
	2½	Wine.....	75	90	32
	1	Cordial.....	70	85	60
	1	Pousse Cafe.....	70	85	60
7780	✓ 8	Beer Goblets.....	90	1 05	15
7786	10	Sham Goblets.....	1 20	1 35	10
7787	9	Goblets.....	90	1 05	11
7788	10	Goblets, Bell Top.....	1 10	1 25	10
7787	10	Goblets, Hotel.....	90	1 05	10
7790	✓ 12	Beer Goblets.....	1 00	1 15	8
7795	10	" " ".....	90	1 05	10
7796	✓ 10	" " ".....	90	1 05	10
7797	✓ 10	Beer Goblets.....	90	1 05	10
	✓ 8	" " ".....	90	1 05	12
	✓ 6	" " ".....	80	95	18
	4½	Claret.....	80	95	24
7798	✓ 12	Egg Shape Beer.....	1 00	1 15	8
	✓ 10	" " ".....	90	1 05	10
	✓ 9	" " ".....	90	1 05	11
	✓ 8	" " ".....	90	1 05	12
	✓ 7	" " ".....	80	95	13
	✓ 6	" " ".....	80	95	16
7799	9½	Beer Goblet.....	90	1 05	10

Old Rochester Tumbler Company's numbers, shapes and sizes. One piece drawn stems. Cuts shown actual size. Complete lines made both plain and optic.

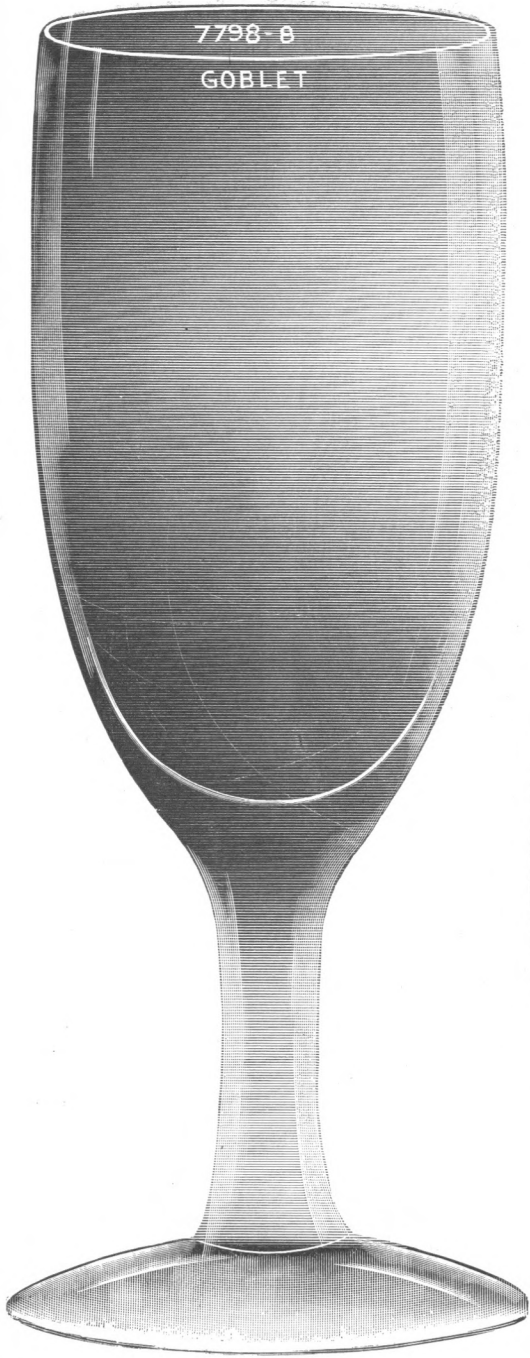

LEAD GLASS BLOWN STEMWARE.

No.	Oz.		Price Dozen Plain	Price Dozen Optic	Doz. in Bbl.
7801	11	Goblet.....	\$ 95	\$1 10	10
✓✓	10	".....	90	1 05	10
✓✓	9	✓ ".....	90	1 05	11
✓	8½	".....	90	1 05	12
✓	7	Champagne.....	80	95	15
✓	6	".....	80	95	15
✓	5	Claret.....	80	95	20
✓	4	".....	80	95	24
✓	5	Fruit.....	1 00	1 15	15
✓	6	Sherbet.....	95	1 10	18
✓	5	✓ ".....	80	95	20
✓	5	Egg Cup.....	80	95	20
✓	3½	Cocktail ✓.....	70	85	24
✓	3	".....	70	85	24
✓	2½	".....	70	85	28
✓	3	Port.....	75	90	30
✓	3	Wine.....	75	90	30
✓	2¼	".....	75	90	35
✓✓	2	".....	75	90	35
✓	1¼	Pousee Cafe.....	70	85	60
✓✓	1	Cordial.....	70	85	60
✓✓	½	Cordial.....	70	85	75
✓✓	¾	Brandy.....	70	85	75
7801	21	Grape Fruit.....	3 50	3 65	5
	5	Grape Fruit, Liner with Peg.....	90	1 05	60
	5	Grape Fruit, Liner with Foot.....	1 00	1 15	50
7802	21	Grape Fruit.....	3 50	3 65	3
	5	" " Liner with Peg.....	90	1 05	60
	5	" " Liner with Foot.....	1 00	1 15	50
✓	11	Goblet.....	95	1 10	10
	10½	".....	90	1 05	10
	10	".....	90	1 05	10
	7½	".....	90	1 05	16
	7	Champagne.....	80	95	16
	5	".....	80	95	18
7802½	10½	Goblet.....	90	1 05	10
7803	✓ 10	✓ Goblet.....	90	1 05	10
	8	✓ ".....	90	1 05	12
	6	Champagne.....	80	95	16
	21	Grape Fruit.....	3 50	3 65	3

Old Rochester Tumbler Company's numbers, shapes and sizes. One piece drawn stems. Cuts shown actual size. Complete lines made both plain and optic.

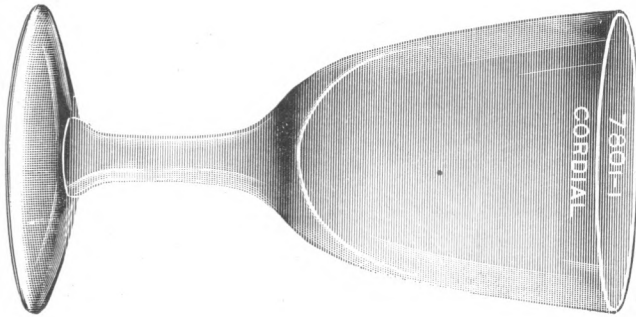

LEAD GLASS BLOWN STEMWARE.

No	Oz.		Price Dozen Plain	Price Dozen Optic	Doz. in Bbl.
7805 ✓	10	Goblet.....	\$ 90	\$1 05	10
	9	"	90	1 05	11
	6½	Champagne.....	80	95	15
	5½	"	80	95	20
	5	Saucer Champagne.....	90	1 05	20
✓	4½	Claret.....	80	95	22
✓	3¾	"	80	95	24
✓	3	Wine.....	75	90	30
✓	2	"	75	90	35
	2½	Cocktail.....	70	85	30
	2	"	70	85	35
✓	2	Sherry.....	75	90	30
✓	1½	"	75	90	35
✓	1	Cordial.....	70	85	60
✓	1	Pousse Cafe.....	70	85	60
✓	7-8	"	70	85	60
✓	7-8	Brandy.....	70	85	60
✓	¾	"	70	85	60
7806	11	Goblet.....	95	1 10	10
	10	"	90	1 05	10
	9	"	90	1 05	11
	8	"	90	1 05	12
	6	Champagne.....	80	95	15
	6	Saucer Champagne.....	90	1 05	13
	5½	"	90	1 05	13
	5	Claret.....	80	95	20
	4	"	80	95	24
	3¾	"	80	95	24
	3	Cocktail.....	70	85	25
	2½	Wine.....	75	90	30
	1¼	Sherry.....	1 00	1 15	36
	1	Cordial.....	70	85	60
	1	Brandy.....	70	85	60
7806½	9	Goblet.....	90	1 05	11
7807	11½	Beer Goblet.....	1 00	1 15	10
	11	"	95	1 10	10
	10½	"	90	1 05	10
	10	"	90	1 05	10
	9	"	90	1 05	11
	8	"	90	1 05	12
	6	Pony Beer.....	80	95	16
	5	"	80	95	18
7808	10	Goblet.....	90	1 05	10

Old Rochester Tumbler Company's numbers, shapes and sizes. One piece drawn stems. Cuts shown actual size. Complete Lines made both plain and optic.



7805-10
GOBLET

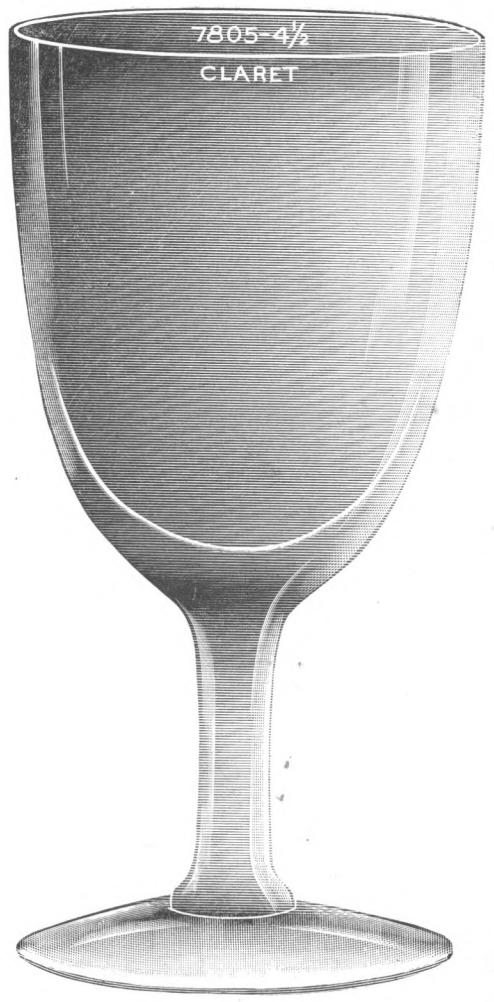

7805-4 1/2
CLARET

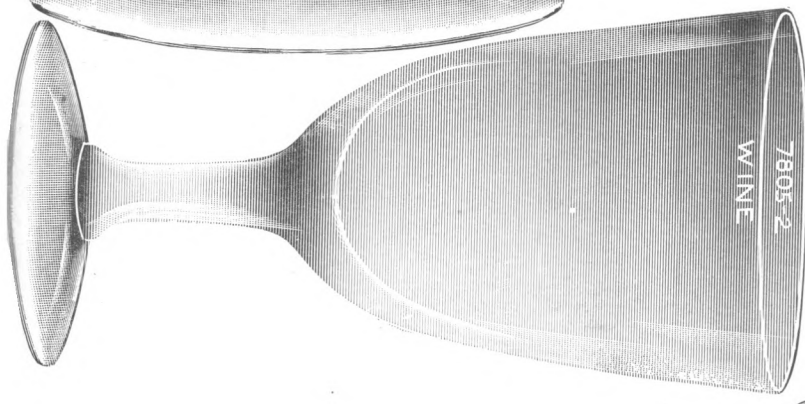

7805-2
WINE



7805-3/4
BR'DY

LEAD GLASS BLOWN STEMWARE.

No.	Oz.		Price Dozen Plain	Price Dozen Optic	Doz. in Bbl.
7810	9	Goblet, Bell Top.....	\$ 90	\$1 05	10
	8	Goblet, Bell Top.....	90	1 05	12
	6	Saucer Champagne, Bell Top.....	90	1 05	12
	5½	High Ball, Bell Top.....	90	1 05	15
	5	Sherbet, Bell Top.....	80	95	20
	5	Claret, Bell Top.....	80	95	18
	4	" ".....	80	95	22
	3½	Cocktail, Bell Top.....	70	85	24
	3	" ".....	70	85	25
	3	Port Wine, Bell Top.....	75	90	30
	2½	Wine.....	75	90	35
	1	Brandy, Bell Top.....	70	85	60
	1	Cordial, Bell Top.....	70	85	60
	1¼	Brandy, Bell Top.....	70	85	60
		Finger Bowl, Bell Top.....	1 40	1 65	16
		Compote, Bell Top.....	2 00	2 15	12
7810½	5½	Sherbet, Bell Top.....	80	95	14
7811	10	Goblet.....	90	1 05	10
7814	11½	".....	1 00	1 15	9
7820	10	Goblet, Table.....	90	1 05	10
7821	9	".....	90	1 05	11
7822	11	Goblet, Hotel.....	95	1 10	10
7824	12	".....	1 00	1 15	9
7825	11	Beer Goblet.....	95	1 10	10
	10	" ".....	90	1 05	10
	9	" ".....	90	1 05	11
	9	" " Long Stem.....	90	1 05	10
	8	" ".....	90	1 05	12
7827	11	Goblet, Table.....	95	1 10	10
7828	15	" Beer.....	1 10	1 25	8
	11	".....	95	1 10	10
	10½	".....	90	1 05	10
	10	".....	90	1 05	10
7830	9	Goblet.....	90	1 05	11
7832	6½	Pony Beer.....	80	95	16
7833	10½	Goblet.....	90	1 05	10
7835	10	Hotel Goblet.....	90	1 05	10
7836	9½	Goblet.....	90	1 05	10
7841	11	Hotel Goblet.....	95	1 10	10
7843	11½	Goblet.....	1 00	1 15	9
	11	".....	95	1 10	10
	10½	".....	90	1 05	10
7849	10	".....	90	1 05	10
	9½	".....	90	1 05	10
	9	".....	90	1 05	11
	8	".....	90	1 05	12
	6	".....			

Old Rochester Tumbler Company's numbers, shapes and sizes. One piece drawn stems. Cuts shown actual size. Complete lines made both plain and optic.

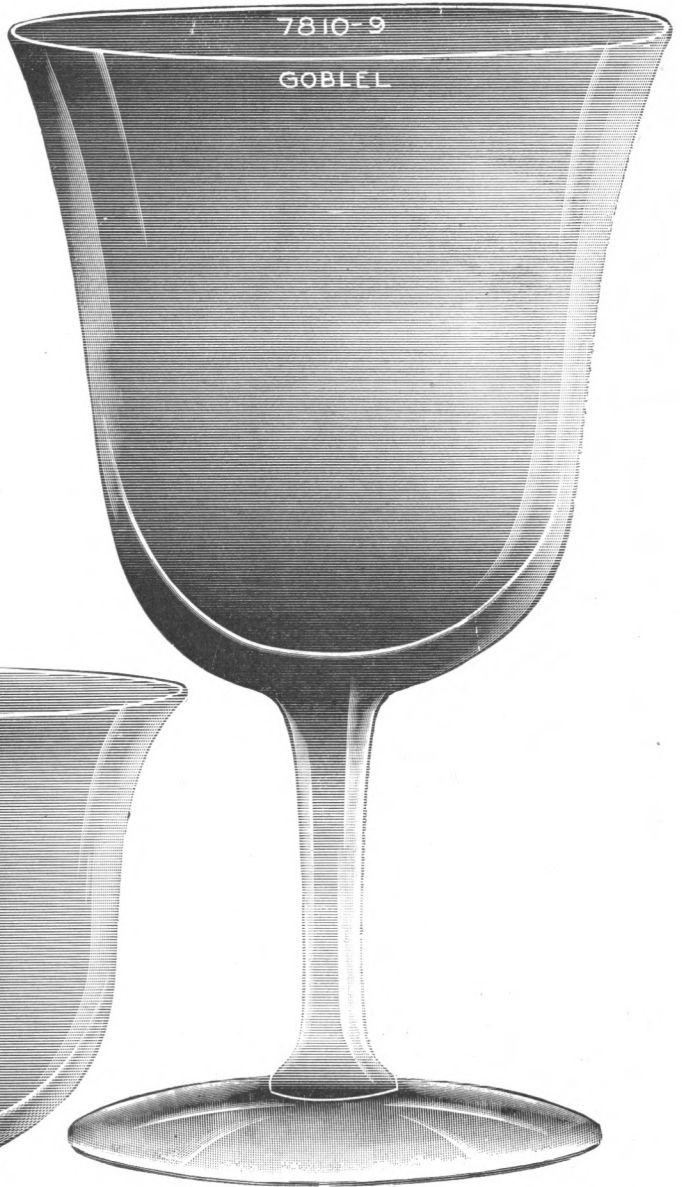

LEAD GLASS BLOWN STEMWARE.

No.	Oz.		Price Dozen Plain	Price Dozen Optic	Doz. in Bbl.
7851	8	Bell Ale.....	\$1 00	\$1 15	10
✓	7	" "	95	1 10	10
	6½	" "	95	1 10	11
✓	6	" "	95	1 10	12
	5	" "	80	95	13
	4	" "	80	95	18
7853	4½	Ale.....	80	95	18
7857	✓ 12	Pilsner Beer.....	1 05	1 20	8
✓	10	" "	1 05	1 20	10
	9½	" "	1 00	1 15	10
✓	9	" "	1 00	1 15	11
✓	8	" "	95	1 10	12
7860	✓ 10	Beer Goblet.....	90	1 05	10
7863	10	" "	90	1 05	10
7864	✓ 9	" "	90	1 05	11
7865	14	Beer Goblet.....	1 10	1 25	8
	11	" "	95	1 10	10
✓	10	" "	90	1 05	10
✓	8	" "	90	1 05	12
	7	Pony Beer.....	80	95	15
✓	6	" "	80	95	16
	6	" " Long Stem.....	80	95	16
	4	" "	80	95	20
7866	10½	Goblet.....	90	1 05	12
7868	4½	Sherbet.....	80	95	20
	3½	Sherbet.....	80	95	25
7869	6	Egg Cup.....	80	95	16
7899	3½	Claret.....	80	95	25
	2½	Wine.....	75	90	28

Old Rochester Tumbler Company's numbers, shapes and sizes. One piece drawn stems. Cuts shown actual size. Complete lines made both plain and optic.

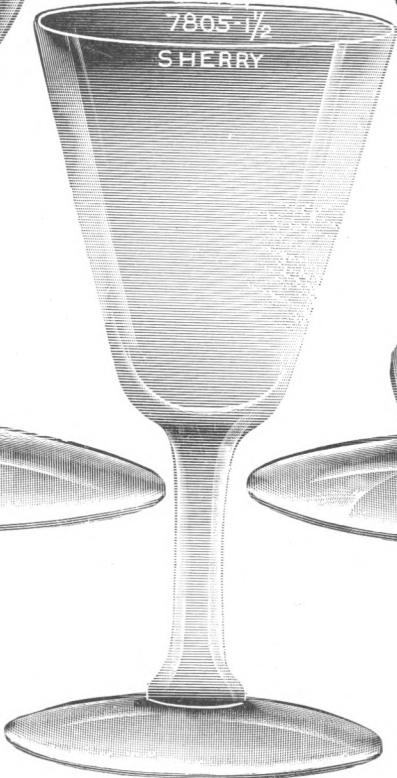
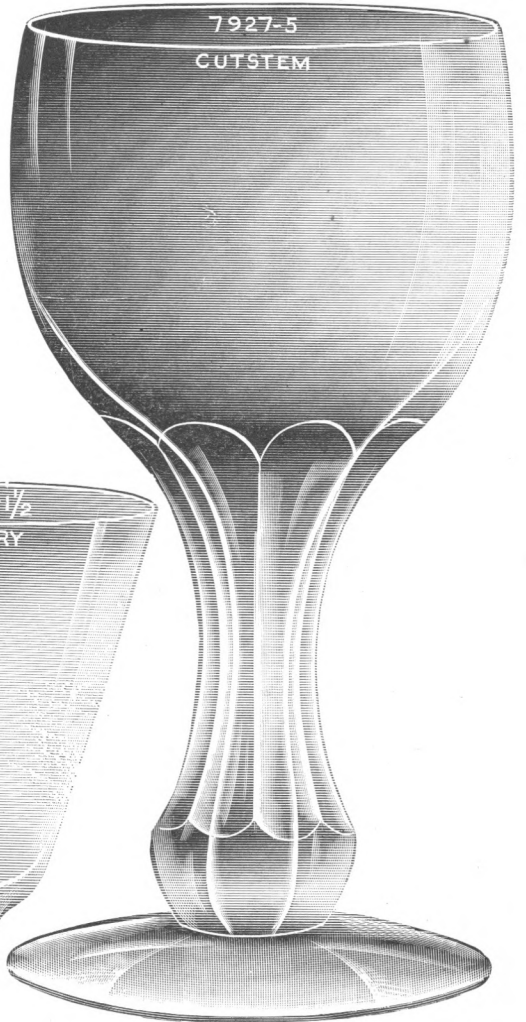

LEAD GLASS BLOWN STEMWARE.

No.	Oz.		Price Dozen Plain	Price Dozen Optic	Doz. in Bbl.
7901	5	Claret.....	\$ 80	\$ 95	20
	✓ 4½	"	80	95	21
	4	"	80	95	20
	3½	"	80	95	25
	✓ 3	Wine.....	75	90	25
7902	5	Claret.....	80	95	24
	4¾	"	80	95	24
	4	"	80	95	25
	3	Wine.....	75	90	28
	2	Sherry.....	75	90	30
7903	3	Cocktail.....	70	85	28
7905	3	"	70	85	28
7906	✓ 3	"	70	85	28
7907	3	"	70	85	28
7908	3	"	70	85	28
	3½	"	70	85	28
7910	2¾	"	70	85	30
	2½	"	70	85	30
7911	✓ 2¾	"	70	85	30
	✓ 3	"	70	85	28
	✓ 3½	"	70	85	25
7912	3	"	70	85	28
	2½	"	70	85	30
7916	✓ 2½	"	70	85	30
7926	✓ 5	Saucer Champ.....	90	1 05	13
7927	✓ 5	Cut Stem Champ.....	1 75	1 90	17
7927 ½	✓ 4½	Cut Stem Champ.....	1 75	1 90	17
7929	6½	Cut Stem Champ.....	3 25	3 40	13
7930	5	Cut Stem Champ. (Cafe Martin).....	2 75	2 90	15
7931	4½	Cafe Parfait.....	1 00	1 15	20

Old Rochester Tumbler Company's numbers, shapes and sizes. One piece drawn stems. Cuts shown actual size. Complete Lines made both plain and optic.

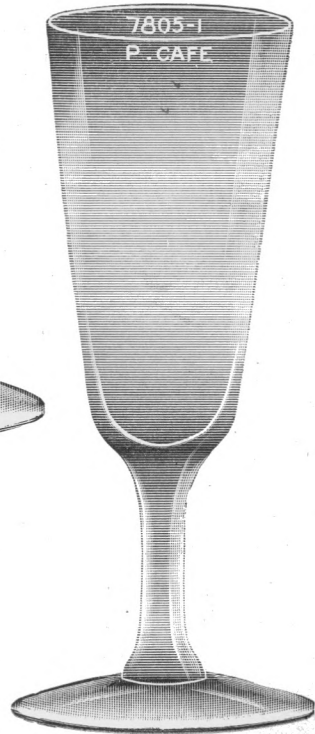
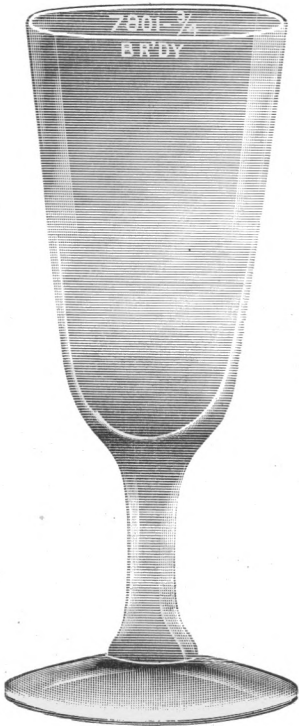
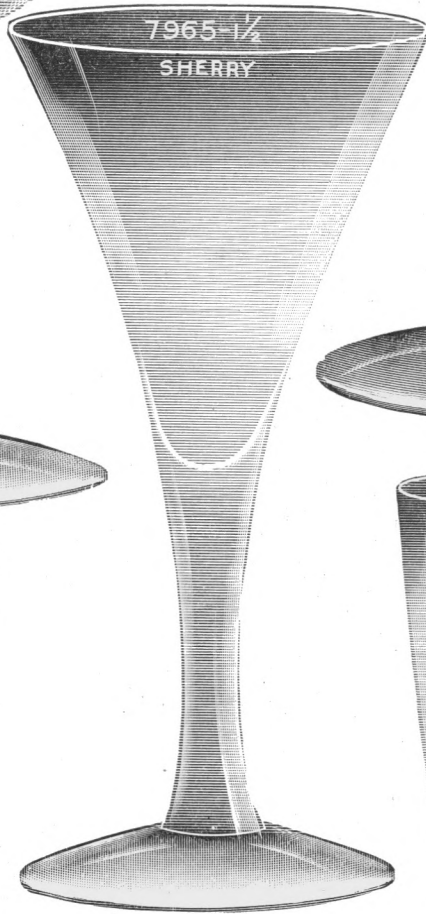
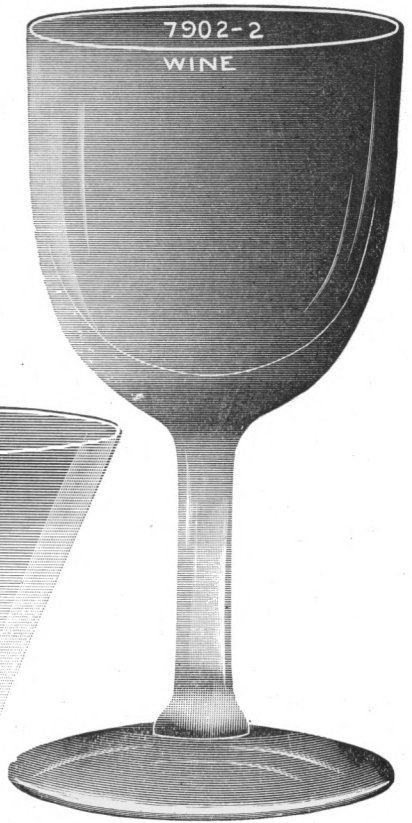
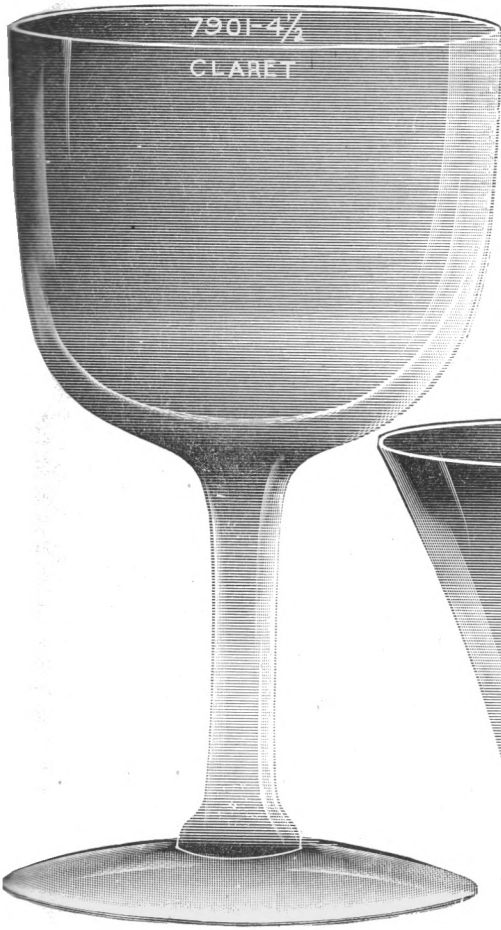

LEAD GLASS BLOWN STEMWARE.

No.	Oz.		Price Dozen Plain	Price Dozen Optic	Doz. in Bbl.
7932	3½	Cocktail.....	\$ 70	\$ 85	25
	3	"	70	85	28
7934	3½	Cocktail.....	70	85	25
	3	"	70	85	25
7941 ✓	9	Bon Bon.....	1 75	1 90	12
7943	4½	Sherbet.....	1 00	1 15	18
7954 ½ ✓	4½	Hot Whiskey.....	80	95	16
	5½	"	80	95	15
7956	4	Sour Wine.....	80	95	20
7965 ✓	2	Sherry.....	1 00	1 15	30
	1½	"	1 00	1 15	35
7966	2	"	1 00	1 15	35
	2	" (Special).....	1 00	1 15	33
7967	2	"	1 00	1 15	30
	1½	"	1 00	1 15	35
7970 ✓	2	"	75	90	30
	1½	"	75	90	35
7981	¾	Cordial.....	70	85	60
7982	¾	Brandy.....	70	85	60
7991	9	Goblet Cut Stem.....	3 00	3 15	10
	7	"	3 00	3 15	12
	5	Claret	2 65	2 80	15
	4	"	2 60	2 75	16
	4	Hot Whiskey	2 60	2 75	16
	3½	Rhine Wine	2 05	2 20	18
	3½	Cocktail	2 05	2 20	18
	2½	"	2 05	2 20	20
	2	"	2 05	2 20	20
	2½	Sherry	1 80	1 95	22
	2	"	1 80	1 95	22
	2½	Wine	1 80	1 95	22
	1½	"	1 80	1 95	24
	1	Cordial	1 80	1 95	30
	1	Pousse Cafe	1 80	1 95	30

For Optic Stemware add 15 cts. per Dozen.

For Optic Grape Fruits add 50 cts. per Dozen.

Old Rochester Tumbler Company's numbers, shapes and sizes. One piece drawn stems. Cuts shown actual size. Complete lines made both plain and optic.



On the following Pages are shown several Table and Beer Goblets in actual size.

We make complete lines in these various shapes. Plain, Optic, Needle Etched or Cut.

On Pages 68 to 74 will be found a schedule of prices that will enable you to determine the price of any article shown or listed in this Book. Whether it be Needle Etched, Deep Plate Etched or Cut.

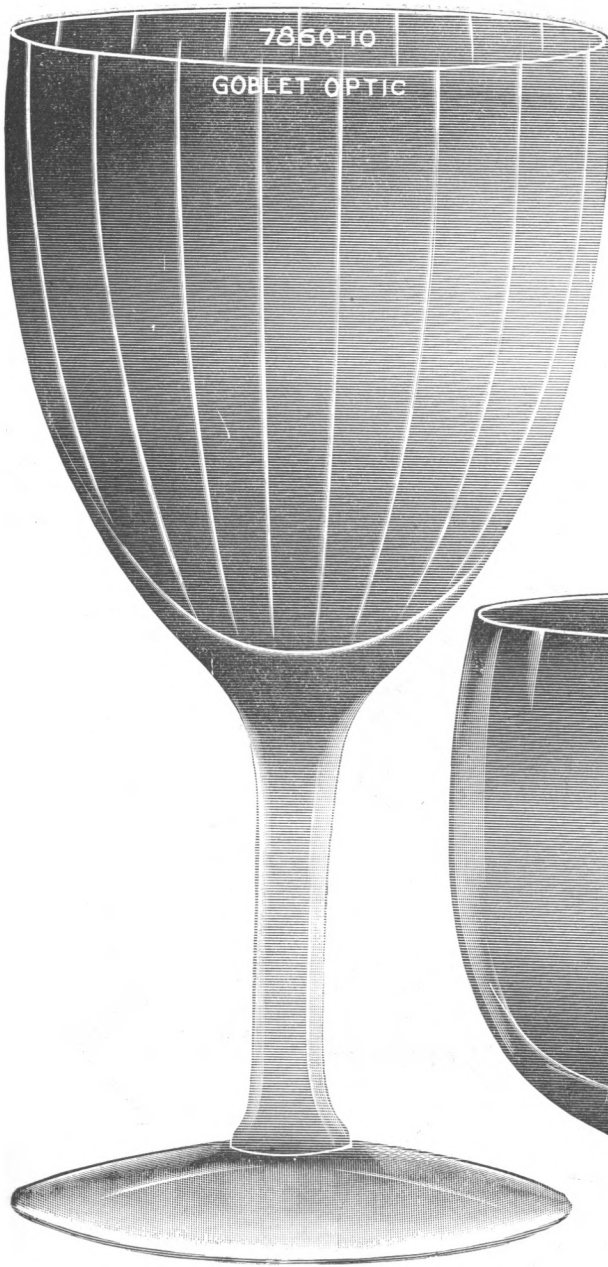



MISCELLANEOUS.

DECORATIONS ON STEMWARE.

Prices indicated for the following decorations are to be added to the price of the plain article.

	Stem Ware	Grape Fruits
For Optic Effect.....	\$ 15	\$ 50
For Needle Etchings, any Design.....	30	1 50
For Deep Plate Etched Monograms.....	60	1 00
For Gold Edge.....	30	50
For Gold Edge and Hair Line.....	35	75
For Engraved No. 411.....	30	1 50

CUT STEMWARE.

Lines No. 7779, 7801, 7802, 7805, 7806, 7807 and 7810 in the following cuttings, take prices indicated.

	Cut 123, ✓	Cut 124, ✓	Cut 73 or 501 ✓	Cut 504	Cut 505 508	Cut 509	Cut 545 ✓	Cut 121 ✓
Goblets.....	\$2 25	\$3 10	\$3 65	\$2 55	\$4 00	\$2 15	\$4 40	\$2 30
Champ.....	2 20	3 00	3 30	2 45	3 90	2 05	4 30	2 10
Sau. Champ..	2 25	3 10	3 65	2 55	4 00	2 15	4 40	2 30
Clarets.....	2 10	3 00	3 20	2 45	3 90	2 05	4 30	2 10
Cocktail.....	2 00	2 95	3 85	2 40	3 85	2 00	4 25	2 05
Egg Cup.....	2 10	3 00	3 30	2 45	3 90	2 05	4 30	2 10
Foot Sher.....	2 10	3 00	3 30	2 45	3 90	2 05	4 30	2 10
Wines.....	1 80	2 85	2 95	2 30	3 70	1 95	4 15	2 05
Cordials.....	1 75	2 75	2 80	2 15	3 55	1 80	4 00	2 00
Brandies.....	1 75	2 75	2 80	2 15	3 55	1 80	4 00	2 00
Pousse Cafe...	1 75	2 75	2 80	2 15	3 15	1 80	4 00	2 00

For Optic add 15 cents to above prices.

No. 300, 301 and 7810 Lines takes 20 cents advance on above prices.

BLOWN NAPPIES.

PLAIN, ETCHED AND ENGRAVED.

Size	Price Plain	Star Bottom	Needle Etched	N. E. & Star Bottom	Engr'd 411	Eng. 411 & Star Bottom	Plate Etched & Star Bottom
4 in.	\$ 1 00	\$ 2 05	\$ 1 60	\$ 2 65	\$ 1 55	\$ 2 60	\$ 3 50
4½ in.	1 20	2 30	1 90	3 00	1 85	2 95	4 25
5 in.	1 50	2 65	2 50	3 65	2 25	3 40	5 00
6 in.	1 80	3 25	3 15	4 60	2 65	4 10	7 15
7 in.	2 50	3 80	4 05	5 35	3 45	4 85	8 50
8 in.	3 00	4 70	4 75	6 25	4 00	5 70	10 25
9 in.	4 00	5 60	6 25	7 85	5 15	6 75	12 25

For Deep Nappies add 50 cents to above prices.

CUT NAPPIES.

Size.	Cut 121 3 star	Cut 122 3 star	Cut 122 4 star	Cut 501 505	29 123 124	Cut 503 504	Cut 509	Cut 545
4 in.	\$2 70	\$3 75	\$ 4 30	\$ 3 75	\$ 3 25	\$ 3 10	\$ 3 00	\$ 3 25
4½ in.	2 95	4 05	4 65	4 50	3 50	3 30	3 25	4 40
5 in.	3 35	4 50	5 70	5 00	3 75	3 65	3 60	5 50
6 in.	4 00	5 45	7 50	6 50	5 25	5 00	5 00	6 50
7 in.	5 00	6 30	9 65	8 50	7 25	7 10	7 10	8 50
8 in.	5 75	7 45	10 80	10 50	9 50	9 25	9 25	10 50
9 in.	7 50	8 60	13 60	12 50	11 50	11 50	11 50	12 50

STRAIGHT TANKARDS.

PLAIN CUT, ETCHED OR ENGRAVED.

No.	Size	Plain	Star Bottom	Needle Etched	Star Bot. & N. E.	Eng'd 411-475	Deep Etched
1	8 oz.	\$1 35	\$2 35	\$2 35	\$3 25	\$2 25	\$3 25
2	10 "	1 65	2 65	2 65	3 65	2 50	4 80
3	15 "	2 20	3 45	3 45	4 55	3 25	6 10
3½	21 "	2 45	3 75	3 75	5 00	3 50	6 75
4	31 "	2 75	4 25	4 25	5 75	4 00	8 00
5	42 "	3 30	4 95	4 95	6 45	4 60	9 05
5½	48 "	3 65	5 40	5 65	7 00	5 35	9 75
6	54 "	4 00	5 75	6 00	7 75	5 75	10 60
7	65 "	4 25	6 10	6 25	8 10	5 85	13 00

No. 8-54 oz. Concave Tankard takes same price as 54 oz. Straight Tankard.
For Optic add 50 cents per Dozen.

CUT STRAIGHT TANKARDS.

Cut	8 oz.	10	15	21	31	42	48	54	65
9	\$ 4 25	\$ 4 65	\$ 5 25	\$ 6 00	\$ 7 00	\$ 8 25	\$ 9 50	\$10 75	\$12 10
29	6 00	6 50	7 25	8 25	9 00	10 00	11 25	12 50	14 00
73	6 50	7 00	8 00	10 00	12 00	15 00	17 00	18 00	21 00
122									
3 Star	4 35	4 65	5 55	6 15	6 75	7 65	8 40	8 75	9 10
122									
7 Star	7 05	7 35	8 55	9 35	10 10	11 25	12 40	12 75	13 10
122									
11 Star	9 75	10 05	11 55	12 55	13 45	14 85	16 40	16 75	17 10
123	6 00	6 50	7 25	8 25	9 00	10 00	12 00	14 00	15 00
124	6 00	6 50	7 25	8 25	9 00	10 00	12 00	14 00	15 00
224	15 25	16 50	17 25	18 00	19 00	19 75	20 00	21 00	24 00
503	5 00	5 75	6 75	7 50	8 50	9 50	10 50	11 25	12 00
505	8 00	8 50	9 75	11 50	13 00	14 75	16 50	18 00	21 00
509	4 00	4 75	5 75	6 50	7 50	8 50	9 50	10 25	11 00
512	5 00	5 50	6 25	7 00	8 00	9 25	10 75	12 00	13 50

For Optic add 50 cents per Dozen.



No. 303 LINE SQUAT JUGS.

No. Size	Plain	Star Bot.	Needle Etched	Star Bot. & N. E.	Cut 121	Cut 122	Cut		D.E.
							123 or 124	124	
1 10 oz.	\$1 65	\$2 65	\$2 65	\$3 65	\$2 65	\$3 25	\$ 6 50	\$ 4 80	
2 15 "	2 20	3 45	3 45	4 55	3 30	3 90	7 25	6 10	
3 20 "	2 45	3 75	3 75	5 00	3 80	4 50	8 25	6 75	
4 28 "	2 75	4 25	4 25	5 75	4 40	5 25	9 25	8 25	
5 38 "	3 30	4 95	4 95	6 45	5 10	6 10	10 50	9 55	
6 54 "	4 00	5 75	5 75	7 75	5 85	7 35	12 50	11 60	
7 73 "	4 75	6 60	6 60	8 60	6 75	8 35	14 25	13 75	
8 84 "	5 50	7 70	7 70	9 70	7 90	9 70	15 50	15 00	

For Optic add 50 cents per Dozen.

WATER BOTTLES.

No. Plain	Cut 19	Cut 61	Cut 60	Cut 29	Cut 73	Cut 122 3 Star	Cut 122 6 Star	Cut 122 9 Star	
									19
20	3 00	4 10	6 50	6 60	12 50	18 00	10 60	14 60	18 60
21	3 00	4 10	5 50	6 60	12 50	18 00	10 60	14 60	18 60
22	3 00	4 10	5 50	6 60	12 50	18 00	10 60	14 60	18 60
26	3 00	4 10	5 50	6 60	12 50	18 00	10 60	14 60	18 60

No. Plain	Cut 123	Cut 503	Cut 509	Cut 512	Cut 545	Plain N. E.	Plain D. E.
20	12 50	11 25	10 25	12 00	21 00	4 50	7 75
21	12 50	11 25	10 25	12 00	21 00	4 50	7 75
22	12 50	11 25	10 25	12 00	21 00	4 50	7 75
26	12 50	11 25	10 25	12 00	21 00	4 50	7 75

For Optic Water Bottles add 50 cents per Dozen.

SUGARS AND CREAMS.

No.		Plain	Cut 122	Cut 121	Cut 123	Cut 224
7	Sugar	\$2 15	\$4 00	\$3 25	\$4 25	\$5 85
7	Cream	1 65	3 50	2 75	3 75	5 35
8	Sugar	2 15	4 00	3 25	4 25	5 85
8	Cream	1 65	3 50	2 75	3 75	5 35

For Optic add 50 cents per Dozen.

For Needle Etch add \$1.00 per Dozen.

For Plate Etch add \$2.25 per Dozen.

OILS.

	Cut 60	Cut 61	Cut 29	Cut 73	122 3 Star	Cut 123	Cut 503	505	509 512	545
All Oils	\$3 00	\$5 00	\$4 00	\$7 25	\$10 50	\$6 00	\$7 25	\$7 50	\$10 65	\$6 75 \$12 00

All above prices include Cut Stoppers ground in.

For Optic add 50 cents per Dozen.

For Needle Etch add \$1.00 per Dozen.

For Plate Etch add \$2.25 per Dozen.

DECANTERS.

No.		Plain	Cut 19	Cut 60	Cut 61	Cut 63	D. E. 703	Cut 121	Cut 122
19	8 oz.	\$3 30	\$4 05	\$5 75	\$5 00	\$ 6 25	\$11 50	\$ 6 80	\$ 7 80
"	16	3 85	4 85	7 00	6 00	7 50	12 50	8 50	9 50
"	24	4 50	5 50	8 00	7 00	8 50	13 50	10 00	11 00
"	32	5 50	6 25	9 50	8 50	10 00	15 00	11 50	12 50

Columbus Decanter, same prices as 19-16 oz.

All above prices include cut stoppers, ground in.

For Optic add 50 cents per Dozen.

For Needle Etching on 8 oz. add \$1.50; on larger sizes add \$2.00 per Dozen.

For putting on Handles add \$2.00 per Dozen.

SUNBURST.

	Add to price of plain article for 3 stars per doz.	For each additional star
On Whiskeys to 3½ oz. inc.....	\$1 10	\$ 35
" 3¼ to 5¼ oz. inc.....	1 15	40
Tumblers 6 to 7 oz. inc.....	1 20	40
" over 7 oz.....	1 25	45
Stemware to 6 oz. inc.....	1 30	45
" over 6 oz.....	1 40	45
" Saucer Champagne.....	1 40	50
Finger Bowls.....	1 75	60
Stem Sherbets.....	1 20	40
Custards Handled.....	1 20	40
8 and 10 oz. Jugs.....	2 00	70
15 oz. Jugs.....	2 25	75
21 oz. Jugs.....	2 40	80
31 oz. Jugs.....	2 50	85
42 oz. Jugs.....	2 70	90
48 oz. Jugs.....	3 00	1 00
54 oz. Jugs.....	3 00	1 00
65 oz. Jugs.....	3 00	1 00
Oils.....	2 00	70
Water Bottles.....	4 00	1 35
Nappies, 4 inch.....	1 70	55
Nappies, 4½ inch.....	1 75	60
Nappies, 5 inch.....	1 85	60
Nappies, 6 inch.....	2 20	75
Nappies, 7 inch.....	2 50	85
Nappies, 8 inch.....	2 75	90
Nappies, 9 inch.....	3 00	1 00

ADD FOR 16 POINT STARS ON BOTTOMS.

		Doz.
	Tumblers.....	\$ 50
	Custard.....	75
	Finger Bowls.....	90
	Finger Bowls Plates.....	1 30
	Sugars.....	1 00
	Creams.....	1 00
	Oils.....	1 00
	Custard Plates.....	1 30
4 in.	Nappies.....	1 05
4½	“.....	1 10
5	“.....	1 15
6	“.....	1 30
7	“.....	1 45
8	“.....	1 60
9	“.....	1 70
8 & 10 oz.	Tankards.....	1 00
15	“.....	1 10
21	“.....	1 30
31	“.....	1 50
42	“.....	1 65
48	“.....	1 75
54	“.....	1 75
65	“.....	1 85
	Claret Jugs.....	1 75
	Whiskey Jugs.....	1 75

Price for 24 point star when wanted, add 33¼ per cent to above.

NEEDLE POINT ETCHING ON BLOWN WARE.

Add to price of plain ware.

On Tumblers.....	\$ 25
Stemware.....	30
Custards.....	35
Finger Bowls.....	75
Quart Decanters.....	2 00
Pint ".....	2 00
Claret Jugs.....	2 25
Water Bottles.....	1 50
Pitchers (54 Oz. to 65 Oz.).....	2 00
Catsups.....	1 50
Horse Radish Jars.....	50
Bitter Bottles.....	1 75
Oils and Vinegars.....	1 00
8 & 10 oz. Tankards.....	1 00
15 & 21 oz. ".....	1 25
31 & 42 oz. ".....	1 50
48 to 65 oz. ".....	2 00
80 oz. ".....	2 25
4 inch Nappies or less.....	60
4½ " ".....	70
5 " ".....	85
6 " ".....	1 35
7 " ".....	1 55
8 " ".....	1 75
9 " ".....	2 25

Minimum Prices for Deep Etching, Add

Tumblers.....	\$ 60
Stemware.....	75
Finger Bowls.....	1 50
" " Plates.....	95
Hdl. Custard.....	1 00
" " Plates.....	95
4 in. Nappies.....	1 05
4½ ".....	1 40
5 ".....	1 60
6 ".....	3 10
7 ".....	3 70
8 ".....	4 35
9 ".....	5 55
8 oz. Tankard.....	2 25
10 ".....	3 00
15 ".....	3 75
21 ".....	4 10
31 ".....	4 50
42 ".....	5 50
48 ".....	5 90
54 ".....	6 35
65 ".....	6 75
Claret Jugs.....	6 75
Water Bottles.....	4 75
Decanters, Quarts.....	4 00
" Pints.....	4 00
Ind. Creams.....	2 00
Ind. Sugar Covs.....	2 00
" " 2 Hdls.....	2 00
Oils.....	2 25
Cracker Jar and Cov.....	9 00

Deep Etched Monograms

Tumblers.....	\$ 55
Custards.....	70
Stemware.....	60
Finger Bowls.....	1 00
Oils.....	2 25

When Deep Etched designs and Monograms are put on same article, the price shall be for Deep Etched Designs, plus 50 per cent. of price for Monogram.

When two Deep Etched Monograms are put on same article, add full price of one Monogram plus 25 per cent.

Table Tumblers
Needle Etched

Table Tumblers
Emery Bands

On Pages 76 and 77 are shown full size cuts of a few of the best selling patterns.

We make all the Rochester Patterns.

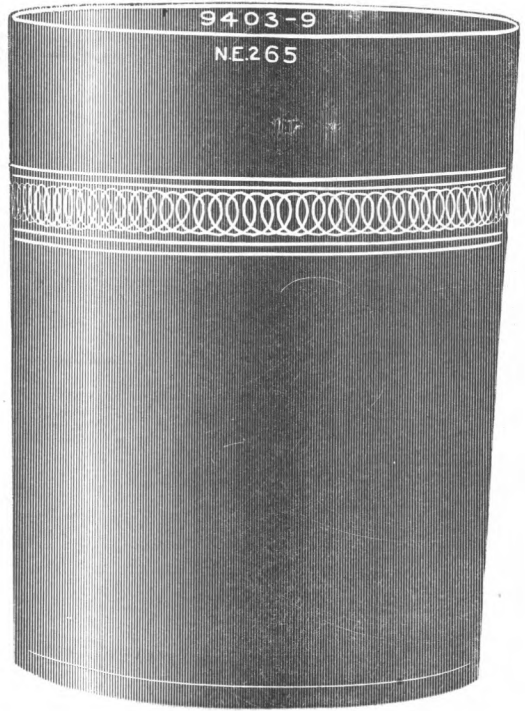
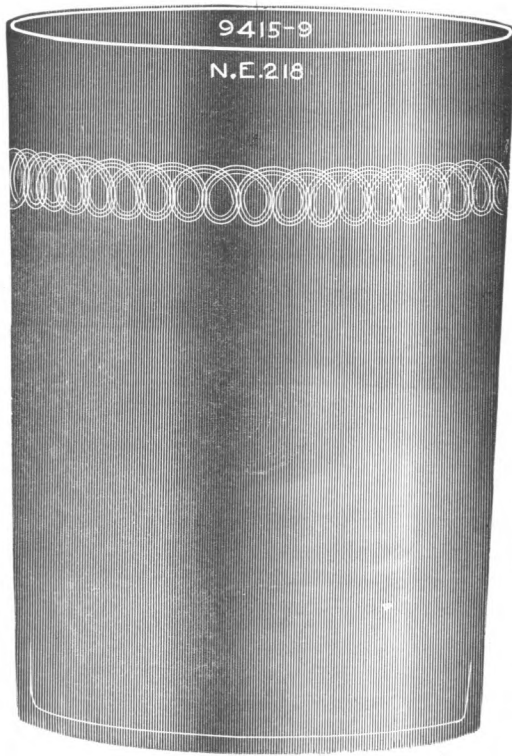



Have full line of stem ware
made by Bryce Bros Co. under their
#390. Our # is 7390.

Will have Fostoria Co's 858 line
of stem ware complete.

Our #7858.

Have the full line of tumblers
ready now our # is 8858.

